

# SKM150GB07E3



SEMITRANS® 2

## Trench IGBT Modules

### SKM150GB07E3

#### Features\*

- $V_{CE(sat)}$  with positive temperature coefficient
- High short circuit capability, self limiting to  $6 \times I_{Cnom}$
- Fast & soft switching inverse CAL diodes
- Insulated copper baseplate using DCB Technology (Direct Copper Bonding)
- With integrated gate resistor

#### Typical Applications

- AC inverter drives
- UPS
- Electronic welders
- Wind power
- Public transport

#### Remarks

- Case temperature limited to  $T_c = 125^\circ\text{C}$  max.
- Recommended  $T_{op} = -40 \dots +150^\circ\text{C}$
- Product reliability results valid for  $T_j = 150^\circ\text{C}$
- Use of soft  $R_g$  necessary

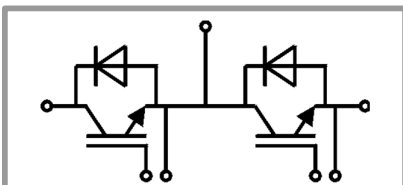

GB

Absolute Maximum Ratings				
Symbol	Conditions	Values	Unit	
<b>IGBT</b>				
$V_{CES}$	$T_j = 25^\circ\text{C}$	650	V	
$I_C$	$T_j = 175^\circ\text{C}$	$T_c = 25^\circ\text{C}$	186	A
		$T_c = 80^\circ\text{C}$	140	A
$I_{Cnom}$		150	A	
$I_{CRM}$		450	A	
$V_{GES}$		-20 ... 20	V	
$t_{psc}$	$V_{CC} = 360\text{ V}$ $V_{GE} \leq 15\text{ V}$ $V_{CES} \leq 650\text{ V}$	$T_j = 150^\circ\text{C}$	6	$\mu\text{s}$
$T_j$			-40 ... 175	$^\circ\text{C}$
<b>Inverse diode</b>				
$V_{RRM}$	$T_j = 25^\circ\text{C}$	650	V	
$I_F$	$T_j = 175^\circ\text{C}$	$T_c = 25^\circ\text{C}$	203	A
		$T_c = 80^\circ\text{C}$	149	A
$I_{FRM}$		300	A	
$I_{FSM}$	$t_p = 10\text{ ms}$ , sin $180^\circ$ , $T_j = 25^\circ\text{C}$	1200	A	
$T_j$			-40 ... 175	$^\circ\text{C}$
<b>Module</b>				
$I_{t(RMS)}$		200	A	
$T_{stg}$	module without TIM	-40 ... 125	$^\circ\text{C}$	
$V_{isol}$	AC sinus 50 Hz, $t = 1\text{ min}$	4000	V	

Characteristics					
Symbol	Conditions	min.	typ.	max.	Unit
<b>IGBT</b>					
$V_{CE(sat)}$	$I_C = 150\text{ A}$ $V_{GE} = 15\text{ V}$ chipelevel	$T_j = 25^\circ\text{C}$	1.46	1.90	V
		$T_j = 150^\circ\text{C}$	1.71	2.10	V
$V_{CE0}$	chipelevel	$T_j = 25^\circ\text{C}$	0.90	1.00	V
		$T_j = 150^\circ\text{C}$	0.82	0.90	V
$r_{CE}$	$V_{GE} = 15\text{ V}$ chipelevel	$T_j = 25^\circ\text{C}$	3.7	6.0	m $\Omega$
		$T_j = 150^\circ\text{C}$	5.9	8	m $\Omega$
$V_{GE(th)}$	$V_{GE} = V_{CE}$ , $I_C = 2.4\text{ mA}$	5.1	5.8	6.4	V
$I_{CES}$	$V_{GE} = 0\text{ V}$ , $V_{CE} = 650\text{ V}$ , $T_j = 25^\circ\text{C}$			0.3	mA
$C_{ies}$	$V_{CE} = 25\text{ V}$ $V_{GE} = 0\text{ V}$	$f = 1\text{ MHz}$	9.2		nF
$C_{oes}$		$f = 1\text{ MHz}$	0.58		nF
$C_{res}$		$f = 1\text{ MHz}$	0.27		nF
$Q_G$	$V_{GE} = -8\text{ V} \dots +15\text{ V}$		1200		nC
$R_{Gint}$	$T_j = 25^\circ\text{C}$		2.0		$\Omega$
$t_{d(on)}$	$V_{CC} = 300\text{ V}$ $I_C = 150\text{ A}$ $V_{GE} = +15/-15\text{ V}$	$T_j = 150^\circ\text{C}$	115		ns
$t_r$		$T_j = 150^\circ\text{C}$	57		ns
$E_{on}$	$R_{Gon} = 3\ \Omega$ $R_{Goff} = 3\ \Omega$	$T_j = 150^\circ\text{C}$	6.5		mJ
$t_{d(off)}$		$T_j = 150^\circ\text{C}$	390		ns
$t_f$	$di/dt_{on} = 2570\text{ A}/\mu\text{s}$ $di/dt_{off} = 2750\text{ A}/\mu\text{s}$ $dv/dt = 3440\text{ V}/\mu\text{s}$	$T_j = 150^\circ\text{C}$	55		ns
$E_{off}$		$T_j = 150^\circ\text{C}$	5.9		mJ
$R_{th(j-c)}$	per IGBT			0.33	K/W
$R_{th(c-s)}$	per IGBT, P12 (reference)		0.071		K/W
$R_{th(c-s)}$	per IGBT, HP-PCM		0.039		K/W



SEMITRANS® 2

## Trench IGBT Modules

### SKM150GB07E3

#### Features\*

- $V_{CE(sat)}$  with positive temperature coefficient
- High short circuit capability, self limiting to  $6 \times I_{Cnom}$
- Fast & soft switching inverse CAL diodes
- Insulated copper baseplate using DCB Technology (Direct Copper Bonding)
- With integrated gate resistor

#### Typical Applications

- AC inverter drives
- UPS
- Electronic welders
- Wind power
- Public transport

#### Remarks

- Case temperature limited to  $T_c = 125^\circ\text{C}$  max.
- Recommended  $T_{op} = -40 \dots +150^\circ\text{C}$
- Product reliability results valid for  $T_j = 150^\circ\text{C}$
- Use of soft  $R_G$  necessary

Characteristics						
Symbol	Conditions		min.	typ.	max.	Unit
<b>Inverse diode</b>						
$V_F = V_{EC}$	$I_F = 150 \text{ A}$ $V_{GE} = 0 \text{ V}$ chipelevel	$T_j = 25^\circ\text{C}$		1.40	1.76	V
		$T_j = 150^\circ\text{C}$		1.39	1.77	V
$V_{F0}$	chipelevel	$T_j = 25^\circ\text{C}$		1.04	1.24	V
		$T_j = 150^\circ\text{C}$		0.85	0.99	V
$r_F$	chipelevel	$T_j = 25^\circ\text{C}$		2.4	3.5	m $\Omega$
		$T_j = 150^\circ\text{C}$		3.6	5.2	m $\Omega$
$I_{RRM}$	$V_{CC} = 300 \text{ V}$	$T_j = 150^\circ\text{C}$		130		A
$Q_{rr}$	$I_F = 150 \text{ A}$ $V_{GE} = -15 \text{ V}$	$T_j = 150^\circ\text{C}$		13.5		$\mu\text{C}$
$E_{rr}$	$di/dt_{off} = 2800 \text{ A}/\mu\text{s}$	$T_j = 150^\circ\text{C}$		2.1		mJ
$R_{th(j-c)}$	per diode				0.375	K/W
$R_{th(c-s)}$	per diode, P12 (reference)			0.076		K/W
$R_{th(c-s)}$	per diode, HP-PCM			0.042		K/W
<b>Module</b>						
$L_{CE}$				30		nH
$R_{CC+EE}$	measured per switch	$T_j = 25^\circ\text{C}$		0.65		m $\Omega$
		$T_j = 150^\circ\text{C}$		1.09		m $\Omega$
$R_{th(c-s)1}$	calculated without thermal coupling, P12 (reference)			0.018		K/W
$R_{th(c-s)2}$	including thermal coupling, $T_s$ underneath module, P12 (reference)			0.030		K/W
$R_{th(c-s)2}$	including thermal coupling, $T_s$ underneath module, HP-PCM			0.0166		K/W
$M_s$	to heat sink M6		3		5	Nm
$M_t$			2.5		5	Nm
	to terminal M5			-		Nm
w					160	g

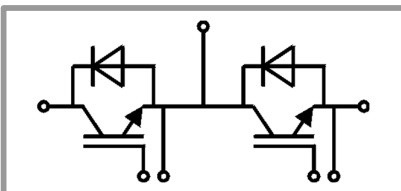

GB

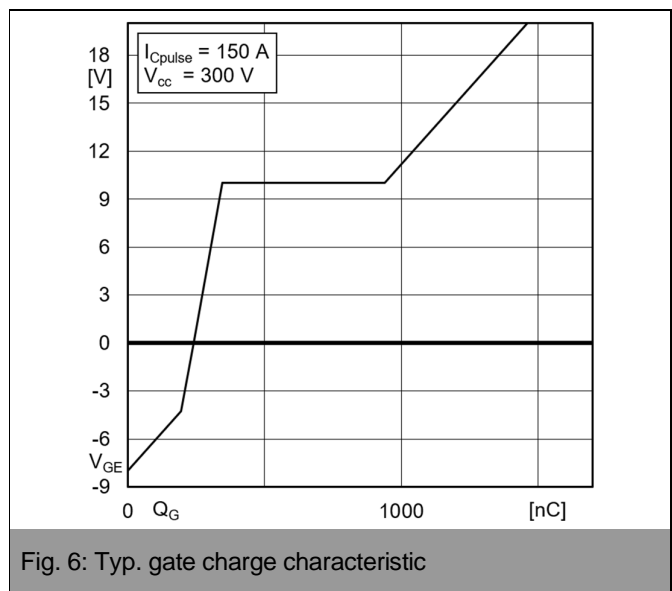
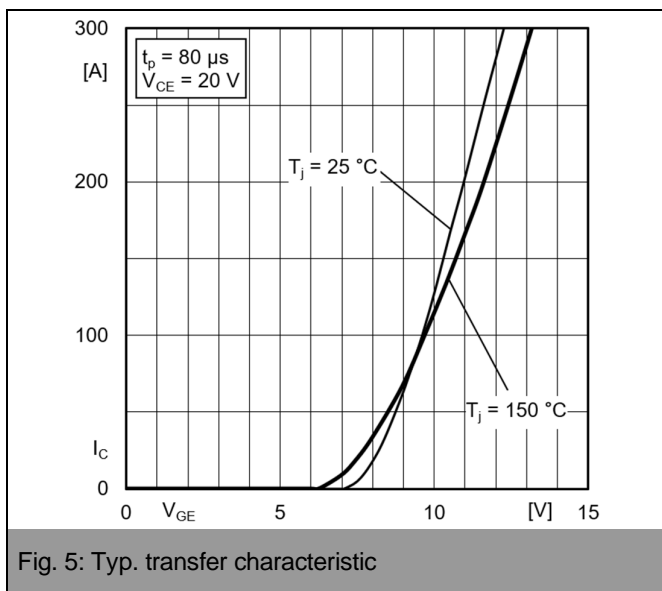
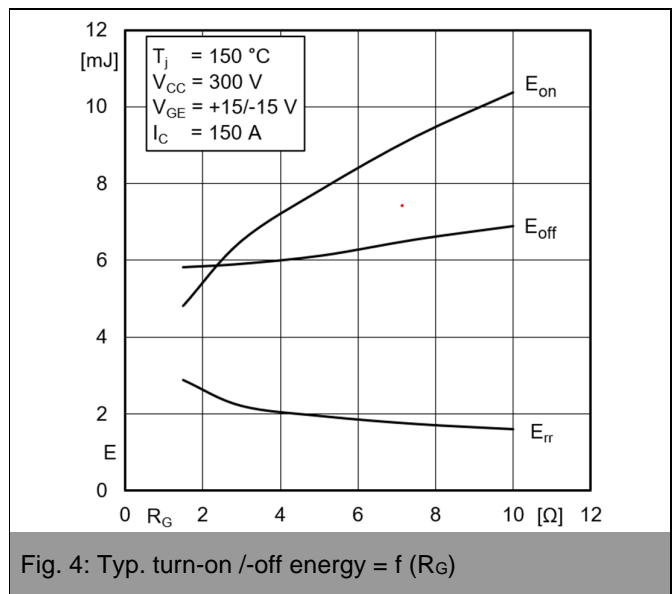
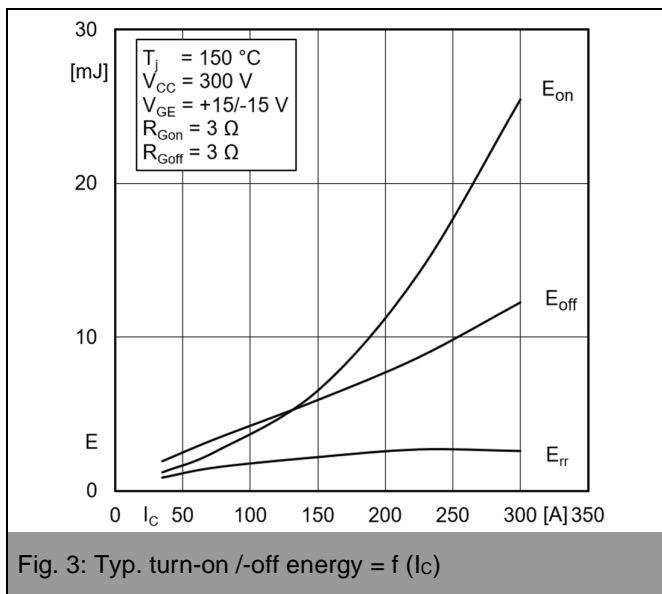
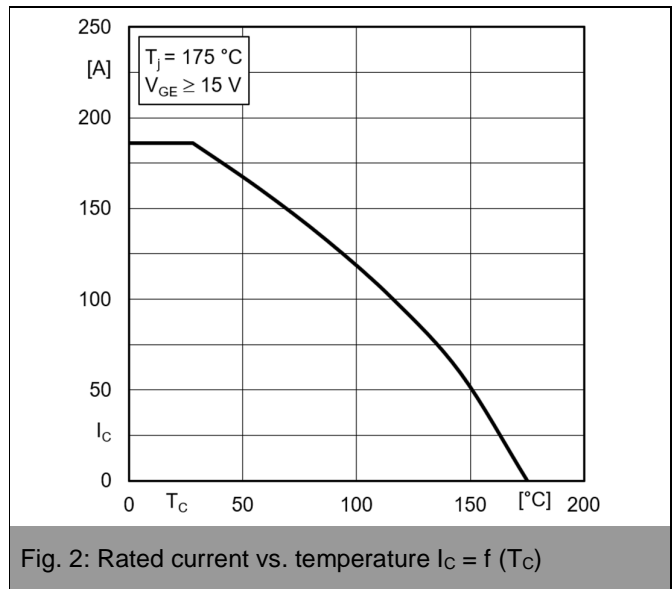
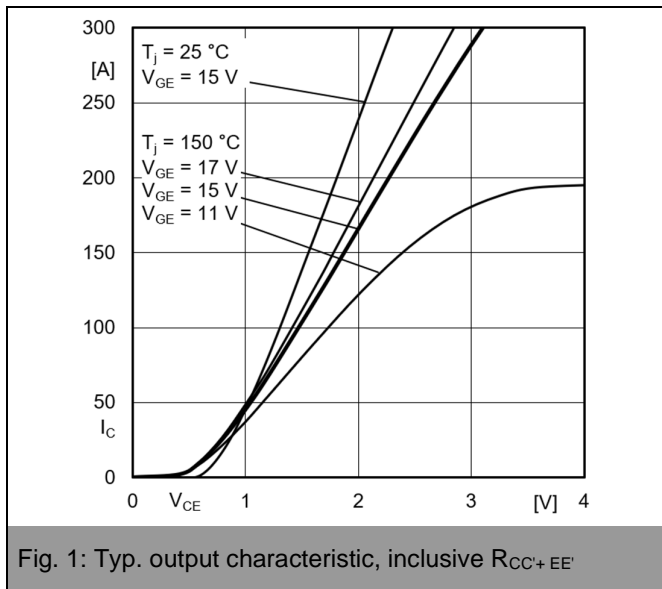

# SKM150GB07E3

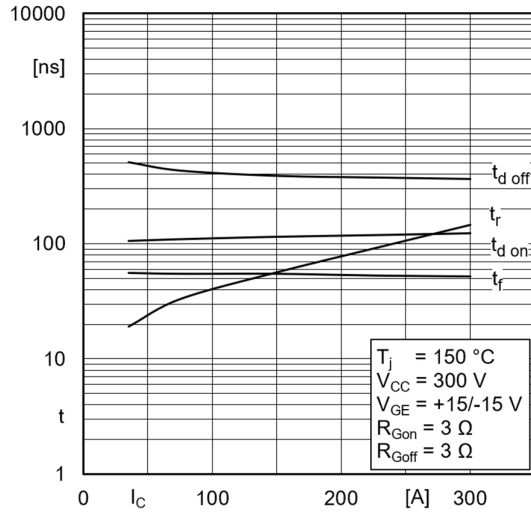

Fig. 7: Typ. switching times vs.  $I_c$

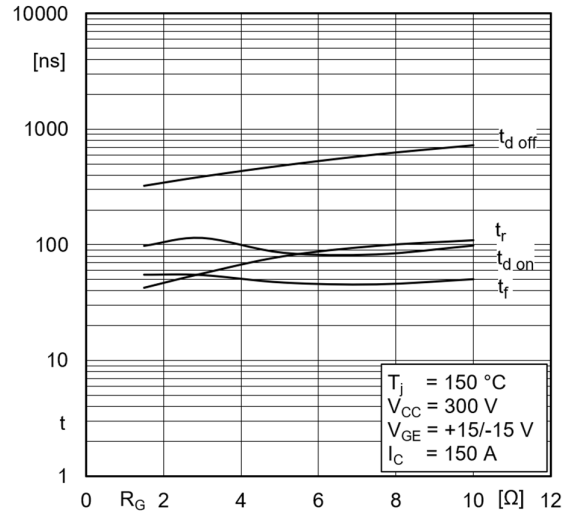

Fig. 8: Typ. switching times vs. gate resistor  $R_G$

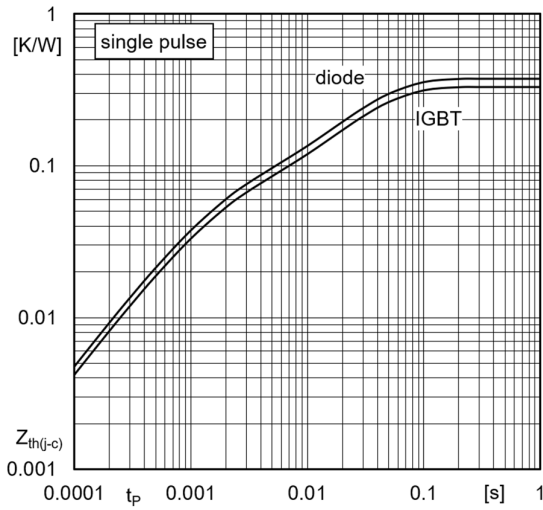

Fig. 9: Transient thermal impedance

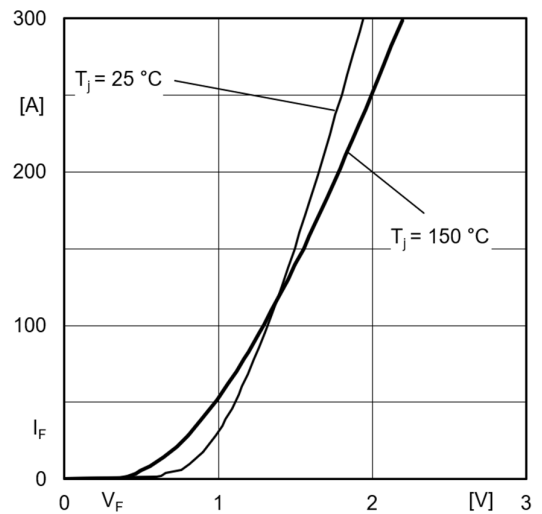

Fig. 10: Typ. CAL diode forward charact., incl.  $R_{CC+EE}$

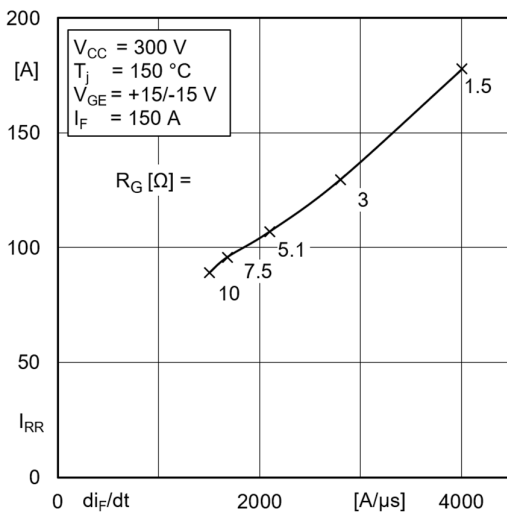

Fig. 11: CAL diode peak reverse recovery current

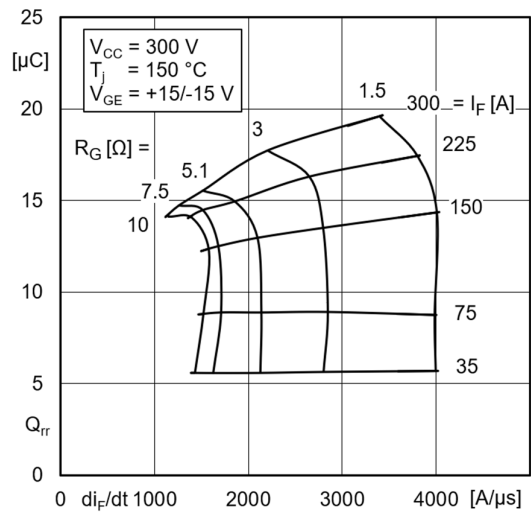
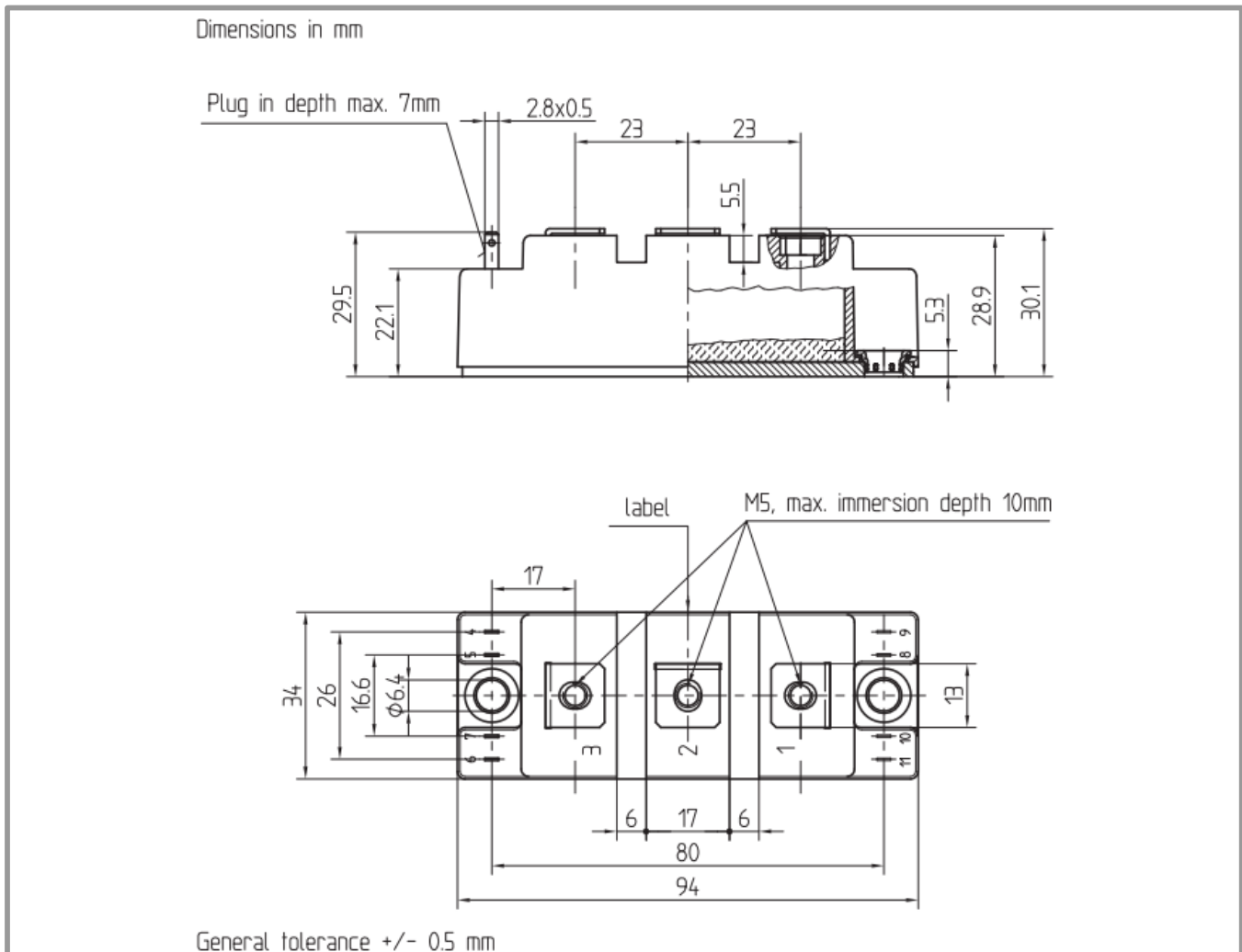
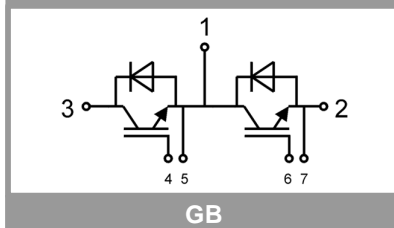

Fig. 12: Typ. CAL diode peak reverse recovery charge



## Pinout and Dimensions



This is an electrostatic discharge sensitive device (ESDS), international standard IEC 60747-1, chapter IX.

### \*IMPORTANT INFORMATION AND WARNINGS

The specifications of SEMIKRON products may not be considered as guarantee or assurance of product characteristics ("Beschaffenheitsgarantie"). The specifications of SEMIKRON products describe only the usual characteristics of products to be expected in typical applications, which may still vary depending on the specific application. Therefore, products must be tested for the respective application in advance. Application adjustments may be necessary. The user of SEMIKRON products is responsible for the safety of their applications embedding SEMIKRON products and must take adequate safety measures to prevent the applications from causing a physical injury, fire or other problem if any of SEMIKRON products become faulty. The user is responsible to make sure that the application design is compliant with all applicable laws, regulations, norms and standards. Except as otherwise explicitly approved by SEMIKRON in a written document signed by authorized representatives of SEMIKRON, SEMIKRON products may not be used in any applications where a failure of the product or any consequences of the use thereof can reasonably be expected to result in personal injury. No representation or warranty is given and no liability is assumed with respect to the accuracy, completeness and/or use of any information herein, including without limitation, warranties of non-infringement of intellectual property rights of any third party. SEMIKRON does not assume any liability arising out of the applications or use of any product; neither does it convey any license under its patent rights, copyrights, trade secrets or other intellectual property rights, nor the rights of others. SEMIKRON makes no representation or warranty of non-infringement or alleged non-infringement of intellectual property rights of any third party which may arise from applications. Due to technical requirements our products may contain dangerous substances. For information on the types in question please contact the nearest SEMIKRON sales office. This document supersedes and replaces all information previously supplied and may be superseded by updates. SEMIKRON reserves the right to make changes.