

Heatsink

Standard lengths	n	b / d Ø mm	R_{thha} K/W	R_{thha} with fan SKF 16B-230-01 K/W	w kg
P 16/170	3	20		0,05	4
P 16/200	3	20		0,046	4,7
	6	20		0,039	
	3	34		0,038	
	2	50		0,04	
P 16/300	3	50		0,033	7
	6	34		0,036	
	6	50		0,024	

For all isolated power modules

P 16

Features

- Intended for all isolated power modules : SEMIPACK, SEMITRANS, SEMIPONT, SKiM, SEMiX, SKiiP
- Excellent efficiency/volume ratio
- Best suited fans : SKF 16-A and SKF 16-B
- Available in various lengths

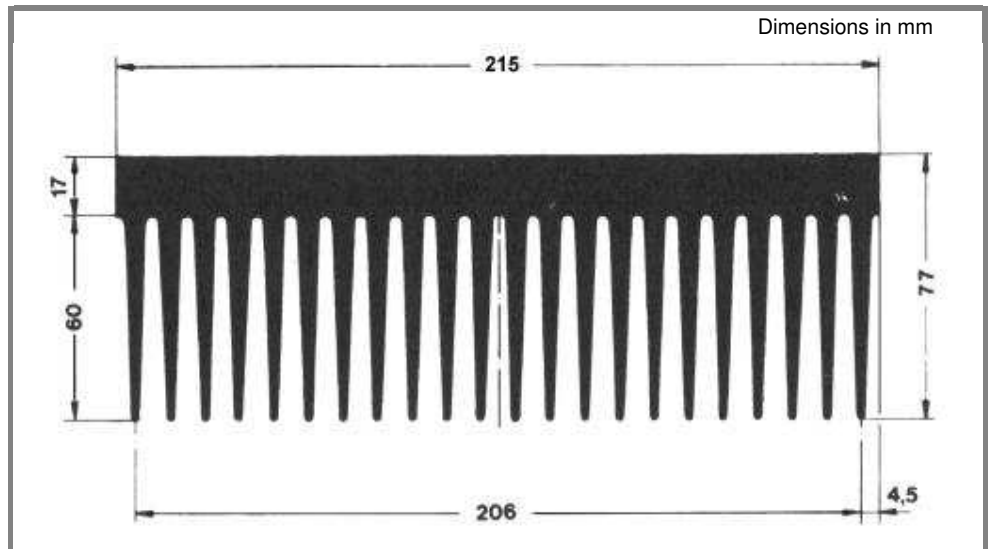

P16 general profile dimensions (w = 23,5 kg/m)

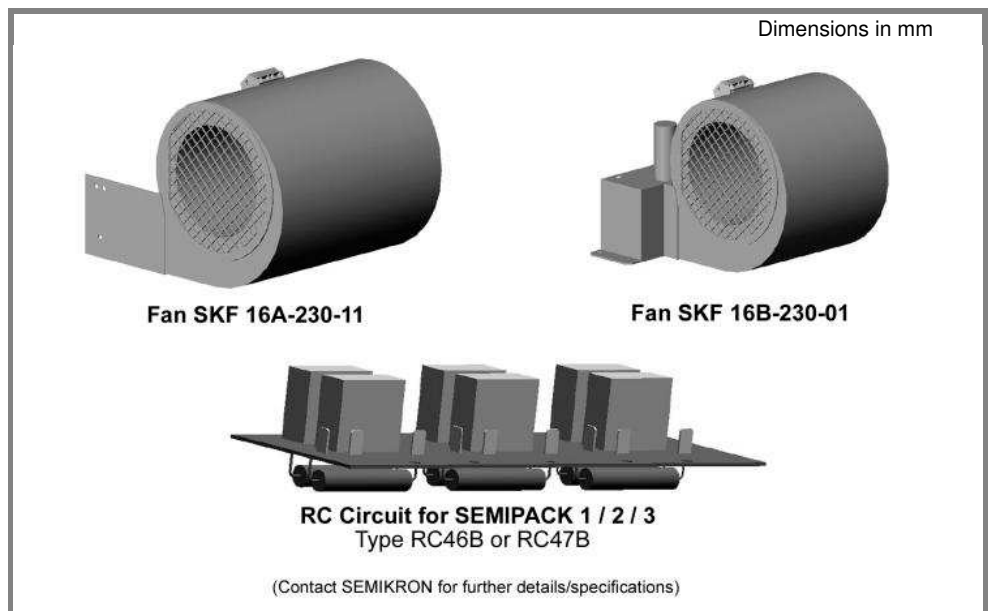

(Contact SEMIKRON for further details/specifications)

P 16 standard accessories

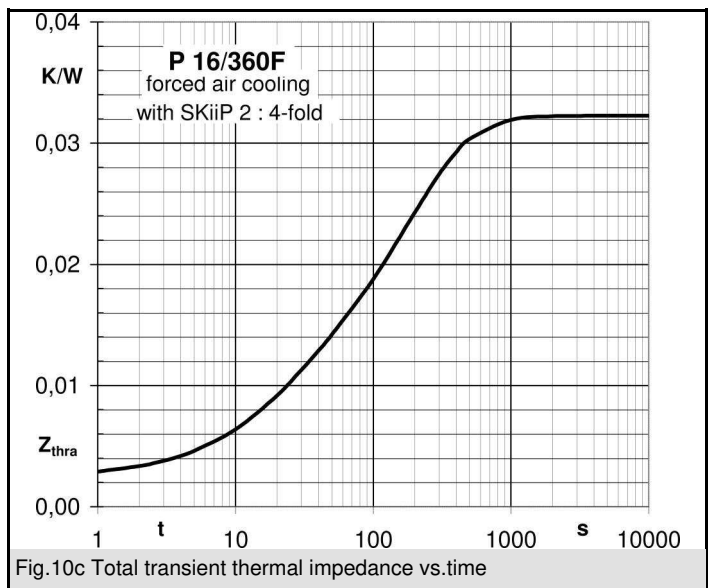
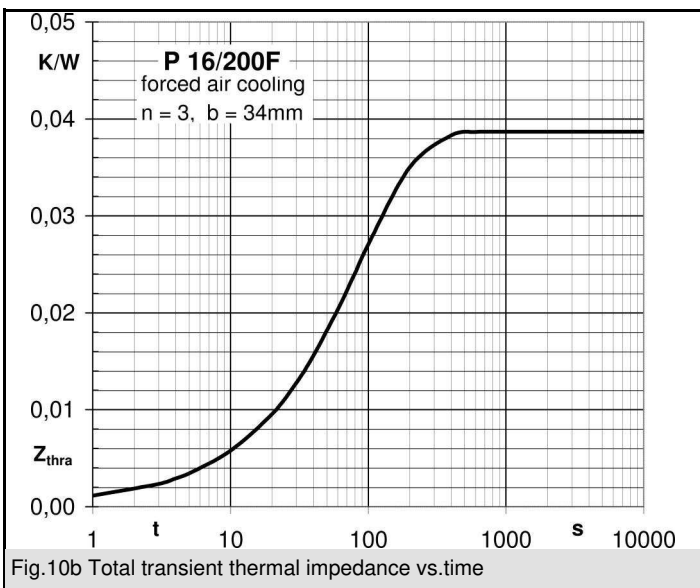
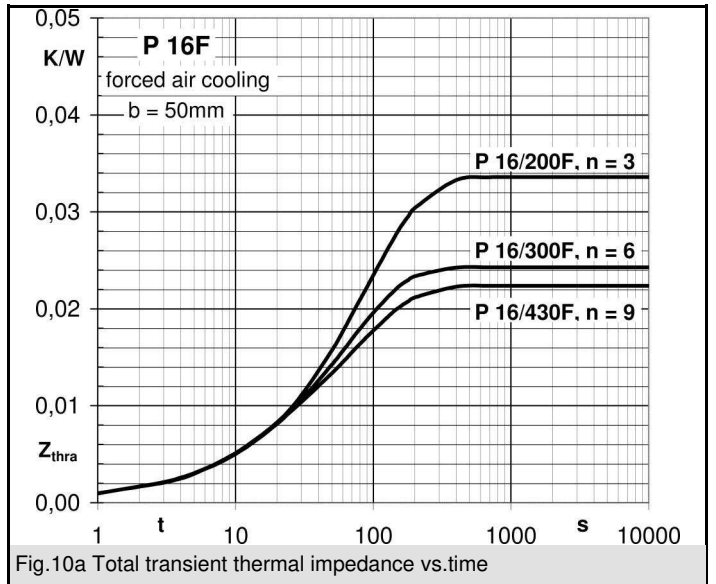
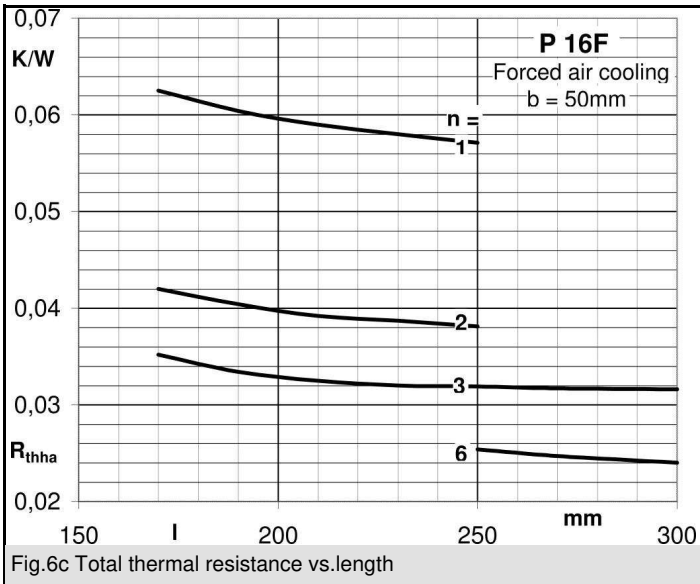
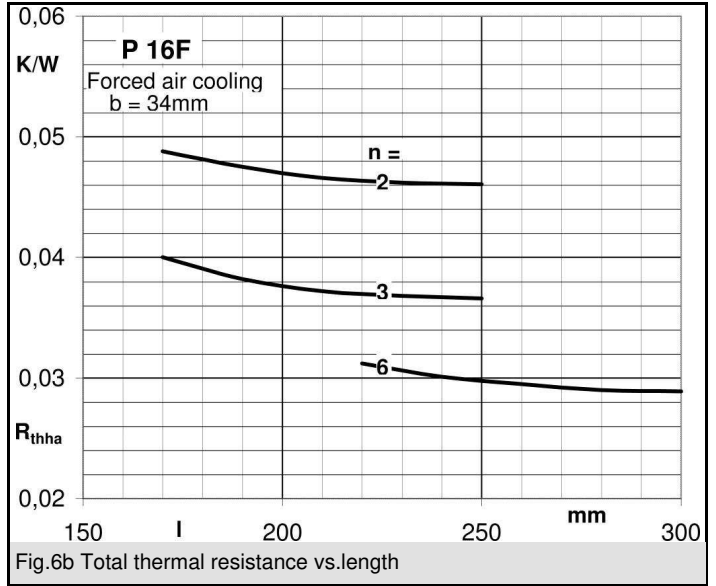
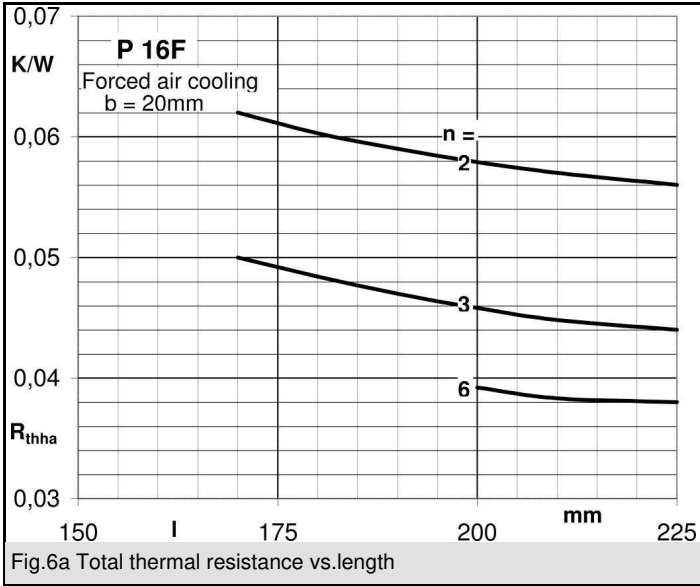

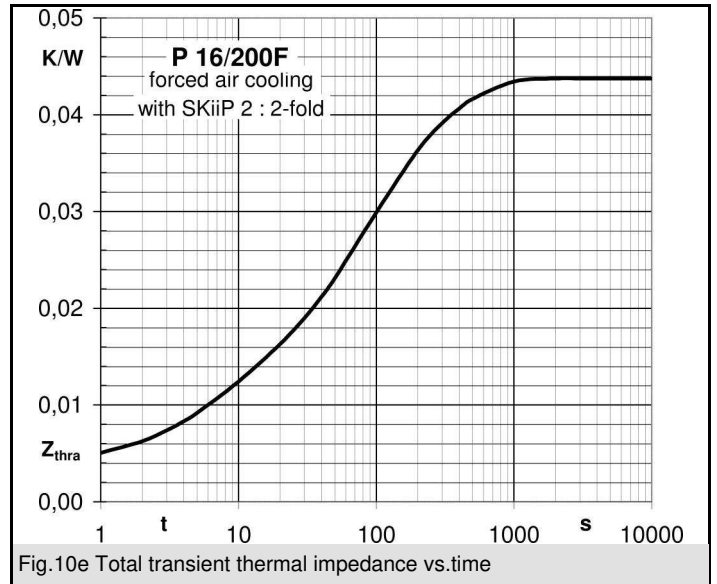
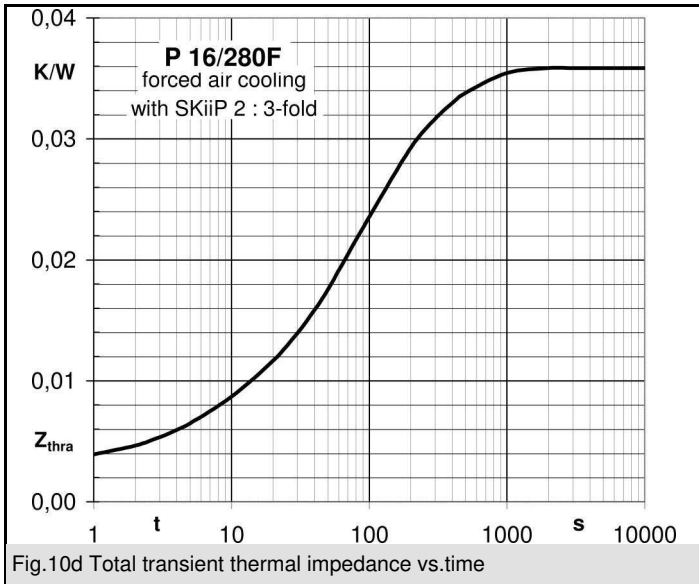

P16/300

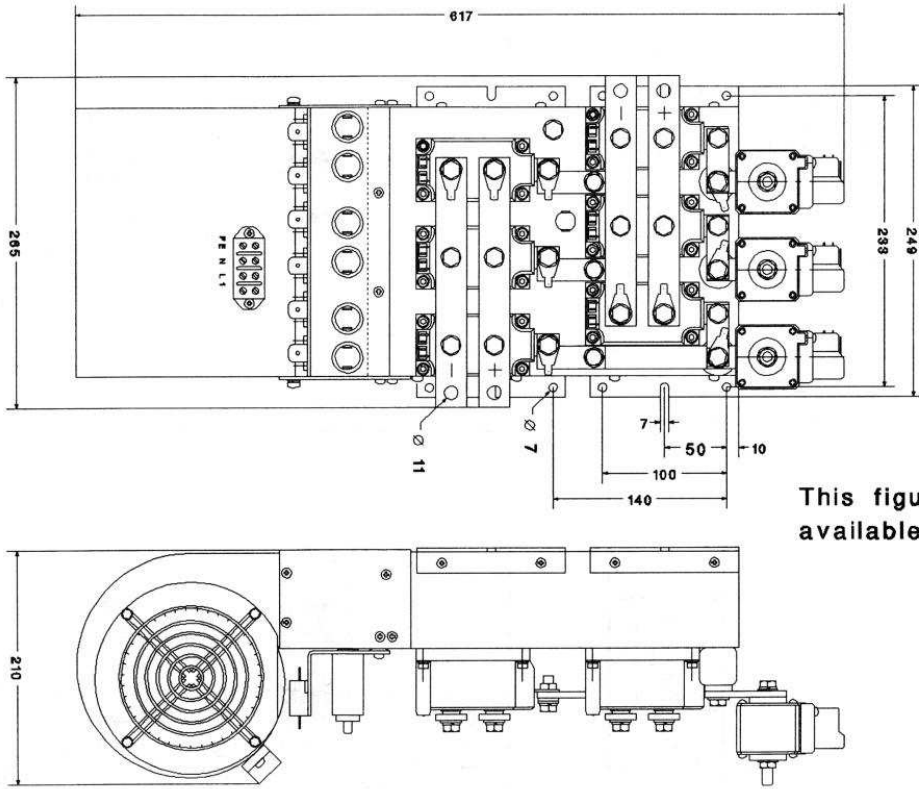

This figure shows all available options

1. Application example using modules and heatsink P 16/300 to give a 4-quadrant converter

P16/200F
P16/280F
P16/360F

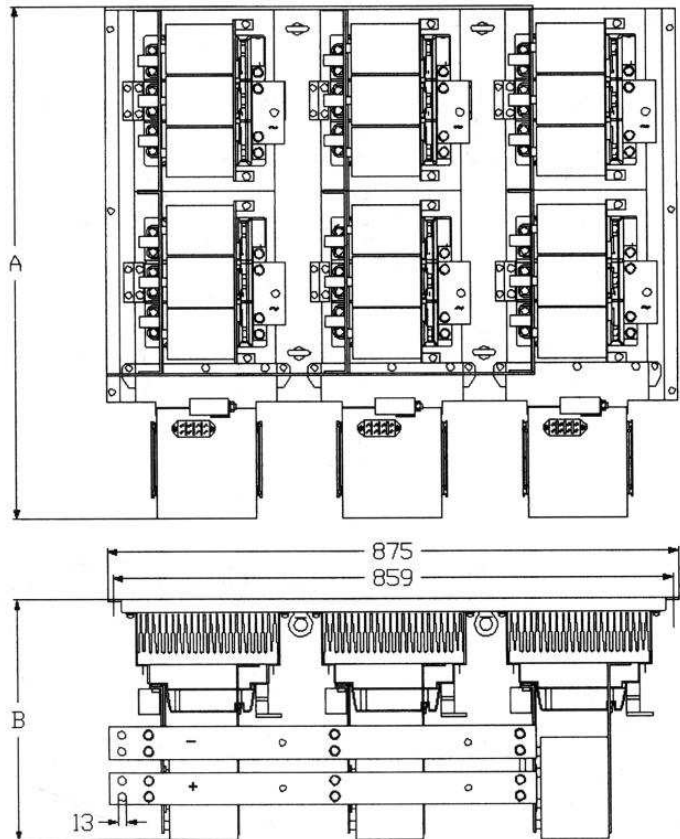

	P16/200F	P16/280F	P16/360F
A	640	800	960
B	600V-SKiiP	370	370
	1200V-SKiiP	420	420
	1700V-SKiiP	505	505
N OF SKiPs PER PHASE	2	2	2

2. Application example using SKiPs and heatsink P 16 to give an IGBT inverter