

SK15DGDL12T7ETE1s



SEMISTOP®E1 Solder

3-phase Converter-Inverter-Brake (CIB)

SK15DGDL12T7ETE1s

Features*

- Optimized design for superior thermal performance
- Low inductive design
- Solder contact technology
- 1200V Generation 7 IGBT (T7)
- Robust and soft switching CAL4F diode technology
- PEP rectifier diode technology for enhanced power and environmental robustness
- Integrated NTC temperature sensor
- UL recognized file no. E 63 532

Typical Applications

- Motor drives
- Air conditioning
- Auxiliary Inverters

Remarks

- Recommended $T_{j,op} = -40 \dots +150 \text{ }^\circ\text{C}$
- $T_{j,op} > 150 \text{ }^\circ\text{C}$ during overload (details on AN19-002)

Absolute Maximum Ratings				
Symbol	Conditions		Values	Unit
Inverter - IGBT				
V_{CES}	$T_j = 25 \text{ }^\circ\text{C}$		1200	V
I_C	$\lambda_{paste}=0.8 \text{ W/(mK)}$	$T_s = 70 \text{ }^\circ\text{C}$	23	A
		$T_j = 175 \text{ }^\circ\text{C}$	18	A
I_C	$\lambda_{paste}=2.5 \text{ W/(mK)}$	$T_s = 70 \text{ }^\circ\text{C}$	26	A
		$T_j = 175 \text{ }^\circ\text{C}$	21	A
I_{Chom}			15	A
I_{CRM}			30	A
V_{GES}			-20 ... 20	V
t_{psc}	$V_{CC} = 800 \text{ V}$ $V_{GE} \leq 15 \text{ V}$ $V_{CES} \leq 1200 \text{ V}$	$T_j = 175 \text{ }^\circ\text{C}$	7	μs
T_j			-40 ... 175	$^\circ\text{C}$
Chopper - IGBT				
V_{CES}	$T_j = 25 \text{ }^\circ\text{C}$		1200	V
I_C	$\lambda_{paste}=0.8 \text{ W/(mK)}$	$T_s = 70 \text{ }^\circ\text{C}$	23	A
		$T_j = 175 \text{ }^\circ\text{C}$	18	A
I_C	$\lambda_{paste}=2.5 \text{ W/(mK)}$	$T_s = 70 \text{ }^\circ\text{C}$	26	A
		$T_j = 175 \text{ }^\circ\text{C}$	21	A
I_{Chom}			15	A
I_{CRM}			30	A
V_{GES}			-20 ... 20	V
t_{psc}	$V_{CC} = 800 \text{ V}$ $V_{GE} \leq 15 \text{ V}$ $V_{CES} \leq 1200 \text{ V}$	$T_j = 175 \text{ }^\circ\text{C}$	7	μs
T_j			-40 ... 175	$^\circ\text{C}$
Inverse - Diode				
V_{RRM}	$T_j = 25 \text{ }^\circ\text{C}$		1200	V
I_F	$\lambda_{paste}=0.8 \text{ W/(mK)}$	$T_s = 70 \text{ }^\circ\text{C}$	17	A
		$T_j = 175 \text{ }^\circ\text{C}$	14	A
I_F	$\lambda_{paste}=2.5 \text{ W/(mK)}$	$T_s = 70 \text{ }^\circ\text{C}$	20	A
		$T_j = 175 \text{ }^\circ\text{C}$	16	A
I_{FRM}			30	A
I_{FSM}	$t_p = 10 \text{ ms, sin } 180^\circ, T_j = 150 \text{ }^\circ\text{C}$		65	A
T_j			-40 ... 175	$^\circ\text{C}$
Freewheeling - Diode				
V_{RRM}	$T_j = 25 \text{ }^\circ\text{C}$		1200	V
I_F	$\lambda_{paste}=0.8 \text{ W/(mK)}$	$T_s = 70 \text{ }^\circ\text{C}$	12	A
		$T_j = 175 \text{ }^\circ\text{C}$	10	A
I_F	$\lambda_{paste}=2.5 \text{ W/(mK)}$	$T_s = 70 \text{ }^\circ\text{C}$	13	A
		$T_j = 175 \text{ }^\circ\text{C}$	11	A
I_{FRM}			20	A
I_{FSM}	$t_p = 10 \text{ ms, sin } 180^\circ, T_j = 150 \text{ }^\circ\text{C}$		36	A
T_j			-40 ... 175	$^\circ\text{C}$

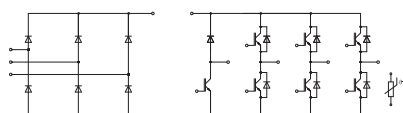

DGDL-ET

SK15DGDL12T7ETE1s



SEMISTOP®E1 Solder

3-phase Converter-Inverter-Brake (CIB)

SK15DGDL12T7ETE1s

Features*

- Optimized design for superior thermal performance
- Low inductive design
- Solder contact technology
- 1200V Generation 7 IGBT (T7)
- Robust and soft switching CAL4F diode technology
- PEP rectifier diode technology for enhanced power and environmental robustness
- Integrated NTC temperature sensor
- UL recognized file no. E 63 532

Typical Applications

- Motor drives
- Air conditioning
- Auxiliary Inverters

Remarks

- Recommended $T_{j,op} = -40 \dots +150 \text{ °C}$
- $T_{j,op} > 150 \text{ °C}$ during overload (details on AN19-002)

Absolute Maximum Ratings				
Symbol	Conditions		Values	Unit
Rectifier - Diode				
V_{RRM}	$T_j = 25 \text{ °C}$		1600	V
I_F	$\lambda_{paste} = 0.8 \text{ W/(mK)}$	$T_s = 70 \text{ °C}$	36	A
		$T_s = 100 \text{ °C}$	29	A
I_F	$\lambda_{paste} = 2.5 \text{ W/(mK)}$	$T_s = 70 \text{ °C}$	40	A
		$T_s = 100 \text{ °C}$	32	A
I_{FSM}	$t_p = 10 \text{ ms}$ $\sin 180^\circ$	$T_j = 25 \text{ °C}$	220	A
		$T_j = 150 \text{ °C}$	200	A
i^2t	$t_p = 10 \text{ ms}$ $\sin 180^\circ$	$T_j = 25 \text{ °C}$	242	A ² s
		$T_j = 150 \text{ °C}$	200	A ² s
T_j			-40 ... 175	°C
Module				
$I_{t(RMS)}$, $\Delta T_{terminal}$ at PCB joint = 30 K, per pin		30	A
T_{stg}	module without TIM		-40 ... 125	°C
V_{isol}	AC, sinusoidal, 1 min		2500	V

Characteristics						
Symbol	Conditions		min.	typ.	max.	Unit
Inverter - IGBT						
$V_{CE(sat)}$	$I_C = 15 \text{ A}$ $V_{GE} = 15 \text{ V}$ chiplevel	$T_j = 25 \text{ °C}$	1.60	1.75		V
		$T_j = 150 \text{ °C}$	1.78	1.93		V
		$T_j = 175 \text{ °C}$	1.82	1.97		V
V_{CE0}	chiplevel	$T_j = 25 \text{ °C}$	1.00	1.05		V
		$T_j = 150 \text{ °C}$	0.80	0.85		V
		$T_j = 175 \text{ °C}$	0.75	0.80		V
r_{CE}	$V_{GE} = 15 \text{ V}$ chiplevel	$T_j = 25 \text{ °C}$	40	47		mΩ
		$T_j = 150 \text{ °C}$	65	72		mΩ
		$T_j = 175 \text{ °C}$	71	78		mΩ
$V_{GE(th)}$	$V_{GE} = V_{CE}, I_C = 0.33 \text{ mA}$		5.15	5.8	6.45	V
I_{CES}	$V_{GE} = 0 \text{ V}, V_{CE} = 1200 \text{ V}, T_j = 25 \text{ °C}$				1	mA
C_{ies}	$V_{CE} = 25 \text{ V}$ $V_{GE} = 0 \text{ V}$	$f = 1 \text{ MHz}$	2.80			nF
C_{oes}		$f = 1 \text{ MHz}$	0.04			nF
C_{res}		$f = 1 \text{ MHz}$	0.01			nF
Q_G	$V_{GE} = -15 \text{ V} \dots +15 \text{ V}$		207			nC
R_{Gint}	$T_j = 25 \text{ °C}$		0			Ω
$t_{d(on)}$	$V_{CC} = 600 \text{ V}$ $I_C = 15 \text{ A}$ $R_{G on} = 7.5 \text{ Ω}$	$T_j = 25 \text{ °C}$	31			ns
		$T_j = 150 \text{ °C}$	33			ns
		$T_j = 175 \text{ °C}$	35			ns
t_r	$R_{G off} = 7.5 \text{ Ω}$ $V_{GE} = +15/-15 \text{ V}$	$T_j = 25 \text{ °C}$	25			ns
		$T_j = 150 \text{ °C}$	27			ns
		$T_j = 175 \text{ °C}$	28			ns
E_{on}	$(T_j = 150 \text{ °C})$ $di/dt_{on} = 730 \text{ A/μs}$ $di/dt_{off} = 150 \text{ A/μs}$ $dv/dt = 2600 \text{ V/μs}$	$T_j = 25 \text{ °C}$	0.79			mJ
		$T_j = 150 \text{ °C}$	1.16			mJ
		$T_j = 175 \text{ °C}$	1.31			mJ

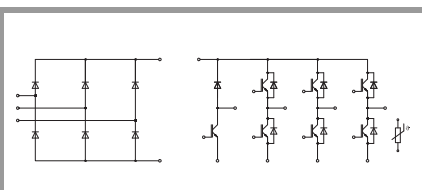

DGDL-ET

SK15DGDL12T7ETE1s



SEMISTOP®E1 Solder

3-phase Converter-Inverter-Brake (CIB)

SK15DGDL12T7ETE1s

Features*

- Optimized design for superior thermal performance
- Low inductive design
- Solder contact technology
- 1200V Generation 7 IGBT (T7)
- Robust and soft switching CAL4F diode technology
- PEP rectifier diode technology for enhanced power and environmental robustness
- Integrated NTC temperature sensor
- UL recognized file no. E 63 532

Typical Applications

- Motor drives
- Air conditioning
- Auxiliary Inverters

Remarks

- Recommended $T_{j,op} = -40 \dots +150 \text{ }^\circ\text{C}$
- $T_{j,op} > 150 \text{ }^\circ\text{C}$ during overload (details on AN19-002)

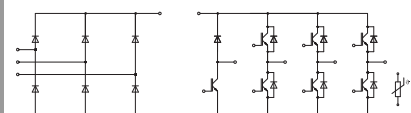

DGDL-ET

Characteristics						
Symbol	Conditions		min.	typ.	max.	Unit
Inverter - IGBT						
$t_{d(off)}$	$V_{CC} = 600 \text{ V}$ $I_C = 15 \text{ A}$ $R_{G, on} = 7.5 \text{ } \Omega$	$T_j = 25 \text{ }^\circ\text{C}$		209		ns
		$T_j = 150 \text{ }^\circ\text{C}$		254		ns
t_f	$R_{G, off} = 7.5 \text{ } \Omega$ $V_{GE} = +15/-15 \text{ V}$	$T_j = 175 \text{ }^\circ\text{C}$		275		ns
		$T_j = 25 \text{ }^\circ\text{C}$		72		ns
		$T_j = 150 \text{ }^\circ\text{C}$		111		ns
		$T_j = 175 \text{ }^\circ\text{C}$		119		ns
E_{off}	$di/dt_{on} = 730 \text{ A}/\mu\text{s}$ $di/dt_{off} = 150 \text{ A}/\mu\text{s}$ $dv/dt = 2600 \text{ V}/\mu\text{s}$	$T_j = 25 \text{ }^\circ\text{C}$		1.29		mJ
		$T_j = 150 \text{ }^\circ\text{C}$		1.71		mJ
		$T_j = 175 \text{ }^\circ\text{C}$		1.95		mJ
$R_{th(j-s)}$	per IGBT, $\lambda_{paste}=0.8 \text{ W}/(\text{mK})$			1.81		K/W
$R_{th(j-s)}$	per IGBT, $\lambda_{paste}=2.5 \text{ W}/(\text{mK})$			1.43		K/W
Chopper - IGBT						
$V_{CE(sat)}$	$I_C = 15 \text{ A}$ $V_{GE} = 15 \text{ V}$ chipelevel	$T_j = 25 \text{ }^\circ\text{C}$		1.60	1.75	V
		$T_j = 150 \text{ }^\circ\text{C}$		1.78	1.93	V
		$T_j = 175 \text{ }^\circ\text{C}$		1.82	1.97	V
V_{CE0}	chipelevel	$T_j = 25 \text{ }^\circ\text{C}$		1.00	1.05	V
		$T_j = 150 \text{ }^\circ\text{C}$		0.80	0.85	V
		$T_j = 175 \text{ }^\circ\text{C}$		0.75	0.80	V
r_{CE}	$V_{GE} = 15 \text{ V}$ chipelevel	$T_j = 25 \text{ }^\circ\text{C}$		40	47	m Ω
		$T_j = 150 \text{ }^\circ\text{C}$		65	72	m Ω
		$T_j = 175 \text{ }^\circ\text{C}$		71	78	m Ω
$V_{GE(th)}$	$V_{GE} = V_{CE}, I_C = 0.33 \text{ mA}$		5.15	5.8	6.45	V
I_{CES}	$V_{GE} = 0 \text{ V}, V_{CE} = 1200 \text{ V}, T_j = 25 \text{ }^\circ\text{C}$				1	mA
C_{ies}	$V_{CE} = 25 \text{ V}$ $V_{GE} = 0 \text{ V}$	$f = 1 \text{ MHz}$		2.80		nF
C_{oes}		$f = 1 \text{ MHz}$		0.04		nF
C_{res}		$f = 1 \text{ MHz}$		0.01		nF
Q_G	$V_{GE} = -15 \text{ V} \dots +15 \text{ V}$			207		nC
R_{Gint}	$T_j = 25 \text{ }^\circ\text{C}$			0		Ω
$t_{d(on)}$		$T_j = 25 \text{ }^\circ\text{C}$		31		ns
		$T_j = 150 \text{ }^\circ\text{C}$		33		ns
		$T_j = 175 \text{ }^\circ\text{C}$		35		ns
t_r		$T_j = 25 \text{ }^\circ\text{C}$		25		ns
		$T_j = 150 \text{ }^\circ\text{C}$		27		ns
		$T_j = 175 \text{ }^\circ\text{C}$		28		ns
E_{on}	$V_{CC} = 600 \text{ V}$ $I_C = 15 \text{ A}$ $R_{G, on} = 7.5 \text{ } \Omega$ $R_{G, off} = 7.5 \text{ } \Omega$ $V_{GE} = +15/-15 \text{ V}$	$T_j = 25 \text{ }^\circ\text{C}$		0.79		mJ
		$T_j = 150 \text{ }^\circ\text{C}$		1.16		mJ
		$T_j = 175 \text{ }^\circ\text{C}$		1.31		mJ
$t_{d(off)}$	$(T_j = 150 \text{ }^\circ\text{C})$ $di/dt_{on} = 730 \text{ A}/\mu\text{s}$ $di/dt_{off} = 150 \text{ A}/\mu\text{s}$ $dv/dt = 2600 \text{ V}/\mu\text{s}$	$T_j = 25 \text{ }^\circ\text{C}$		209		ns
		$T_j = 150 \text{ }^\circ\text{C}$		254		ns
		$T_j = 175 \text{ }^\circ\text{C}$		275		ns
t_f		$T_j = 25 \text{ }^\circ\text{C}$		72		ns
		$T_j = 150 \text{ }^\circ\text{C}$		111		ns
		$T_j = 175 \text{ }^\circ\text{C}$		119		ns
E_{off}		$T_j = 25 \text{ }^\circ\text{C}$		1.29		mJ
		$T_j = 150 \text{ }^\circ\text{C}$		1.71		mJ
		$T_j = 175 \text{ }^\circ\text{C}$		1.95		mJ
$R_{th(j-s)}$	per IGBT, $\lambda_{paste}=0.8 \text{ W}/(\text{mK})$			1.81		K/W
$R_{th(j-s)}$	per IGBT, $\lambda_{paste}=2.5 \text{ W}/(\text{mK})$			1.43		K/W

SK15DGDL12T7ETE1s



SEMITOP®E1 Solder

3-phase Converter-Inverter-Brake (CIB)

SK15DGDL12T7ETE1s

Features*

- Optimized design for superior thermal performance
- Low inductive design
- Solder contact technology
- 1200V Generation 7 IGBT (T7)
- Robust and soft switching CAL4F diode technology
- PEP rectifier diode technology for enhanced power and environmental robustness
- Integrated NTC temperature sensor
- UL recognized file no. E 63 532

Typical Applications

- Motor drives
- Air conditioning
- Auxiliary Inverters

Remarks

- Recommended $T_{j,op} = -40 \dots +150 \text{ °C}$
- $T_{j,op} > 150 \text{ °C}$ during overload (details on AN19-002)

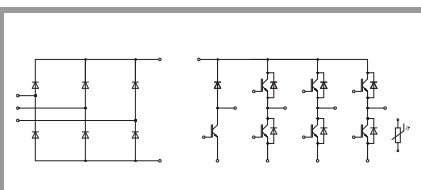

DGDL-ET

Characteristics						
Symbol	Conditions		min.	typ.	max.	Unit
Inverse - Diode						
$V_F = V_{EC}$	$I_F = 15 \text{ A}$	$T_j = 25 \text{ °C}$		2.38	2.71	V
		$T_j = 150 \text{ °C}$		2.44	2.77	V
		chipelevel	$T_j = 175 \text{ °C}$		2.26	2.58
V_{F0}	chipelevel	$T_j = 25 \text{ °C}$		1.30	1.50	V
		$T_j = 150 \text{ °C}$		0.90	1.10	V
		$T_j = 175 \text{ °C}$		0.82	0.98	V
r_F	chipelevel	$T_j = 25 \text{ °C}$		72	81	mΩ
		$T_j = 150 \text{ °C}$		103	111	mΩ
		$T_j = 175 \text{ °C}$		96	107	mΩ
I_{RRM}		$T_j = 25 \text{ °C}$		11		A
		$T_j = 150 \text{ °C}$		15		A
		$T_j = 175 \text{ °C}$		18		A
Q_{rr}	$V_{CC} = 600 \text{ V}$ $I_F = 15 \text{ A}$	$T_j = 25 \text{ °C}$		1.03		μC
		$T_j = 150 \text{ °C}$		2.29		μC
		$T_j = 175 \text{ °C}$		2.58		μC
E_{rr}	$V_{GE} = -15 \text{ V}$ ($T_j = 150 \text{ °C}$) $di/dt_{off} = 870 \text{ A/μs}$	$T_j = 25 \text{ °C}$		0.31		mJ
		$T_j = 150 \text{ °C}$		0.97		mJ
		$T_j = 175 \text{ °C}$		1.49		mJ
$R_{th(j-s)}$	per Diode, $\lambda_{paste}=0.8 \text{ W/(mK)}$			2.13		K/W
$R_{th(j-s)}$	per Diode, $\lambda_{paste}=2.5 \text{ W/(mK)}$			1.74		K/W
Freewheeling - Diode						
$V_F = V_{EC}$	$I_F = 10 \text{ A}$	$T_j = 25 \text{ °C}$		2.59	2.94	V
		$T_j = 150 \text{ °C}$		2.71	3.08	V
		chipelevel	$T_j = 175 \text{ °C}$		2.53	2.89
V_{F0}	chipelevel	$T_j = 25 \text{ °C}$		1.30	1.50	V
		$T_j = 150 \text{ °C}$		0.90	1.10	V
		$T_j = 175 \text{ °C}$		0.82	0.98	V
r_F	chipelevel	$T_j = 25 \text{ °C}$		129	144	mΩ
		$T_j = 150 \text{ °C}$		181	198	mΩ
		$T_j = 175 \text{ °C}$		171	191	mΩ
I_{RRM}		$T_j = 25 \text{ °C}$		8		A
		$T_j = 150 \text{ °C}$		14		A
		$T_j = 175 \text{ °C}$		16		A
Q_{rr}	$V_{CC} = 600 \text{ V}$ $I_F = 10 \text{ A}$	$T_j = 25 \text{ °C}$		0.58		μC
		$T_j = 150 \text{ °C}$		2.01		μC
		$T_j = 175 \text{ °C}$		2.37		μC
E_{rr}	$V_{GE} = -15 \text{ V}$ ($T_j = 150 \text{ °C}$) $di/dt_{off} = 790 \text{ A/μs}$	$T_j = 25 \text{ °C}$		0.36		mJ
		$T_j = 150 \text{ °C}$		0.91		mJ
		$T_j = 175 \text{ °C}$		1.16		mJ
$R_{th(j-s)}$	per Diode, $\lambda_{paste}=0.8 \text{ W/(mK)}$			2.64		K/W
$R_{th(j-s)}$	per Diode, $\lambda_{paste}=2.5 \text{ W/(mK)}$			2.24		K/W

SK15DGDL12T7ETE1s



SEMITOP®E1 Solder

3-phase Converter-Inverter-Brake (CIB)

SK15DGDL12T7ETE1s

Features*

- Optimized design for superior thermal performance
- Low inductive design
- Solder contact technology
- 1200V Generation 7 IGBT (T7)
- Robust and soft switching CAL4F diode technology
- PEP rectifier diode technology for enhanced power and environmental robustness
- Integrated NTC temperature sensor
- UL recognized file no. E 63 532

Typical Applications

- Motor drives
- Air conditioning
- Auxiliary Inverters

Remarks

- Recommended $T_{j,op} = -40 \dots +150 \text{ }^\circ\text{C}$
- $T_{j,op} > 150 \text{ }^\circ\text{C}$ during overload (details on AN19-002)

Characteristics						
Symbol	Conditions		min.	typ.	max.	Unit
Rectifier - Diode						
V_F	$I_F = 15 \text{ A}$ chipelevel	$T_j = 25 \text{ }^\circ\text{C}$		1.04	1.30	V
		$T_j = 150 \text{ }^\circ\text{C}$		0.94	1.20	V
		$T_j = 175 \text{ }^\circ\text{C}$		0.93	1.20	V
V_{F0}	chipelevel	$T_j = 25 \text{ }^\circ\text{C}$		0.89	1.09	V
		$T_j = 150 \text{ }^\circ\text{C}$		0.73	0.92	V
		$T_j = 175 \text{ }^\circ\text{C}$		0.69	0.88	V
r_F	chipelevel	$T_j = 25 \text{ }^\circ\text{C}$		10	14	m Ω
		$T_j = 150 \text{ }^\circ\text{C}$		14	19	m Ω
		$T_j = 175 \text{ }^\circ\text{C}$		16	21	m Ω
I_R	$T_j = 150 \text{ }^\circ\text{C}, V_{RRM}$				2	mA
$R_{th(j-s)}$	per Diode, $\lambda_{paste}=0.8 \text{ W/(mK)}$			1.75		K/W
$R_{th(j-s)}$	per Diode, $\lambda_{paste}=2.5 \text{ W/(mK)}$			1.51		K/W
Module						
M_s	to heatsink		1.6		2.3	Nm
w				25		g
L_{CE}				30		nH
Temperature Sensor						
R_{100}	$T_c=100^\circ\text{C} (R_{25}=5 \text{ k}\Omega)$			$493 \pm 5\%$		Ω
$B_{25/85}$	$R_{(T)}=R_{25} \cdot \exp[B_{25/85} \cdot (1/T - 1/298)]$, T[K]			3420		K

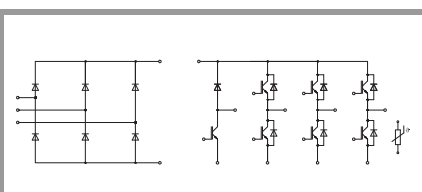

DGDL-ET

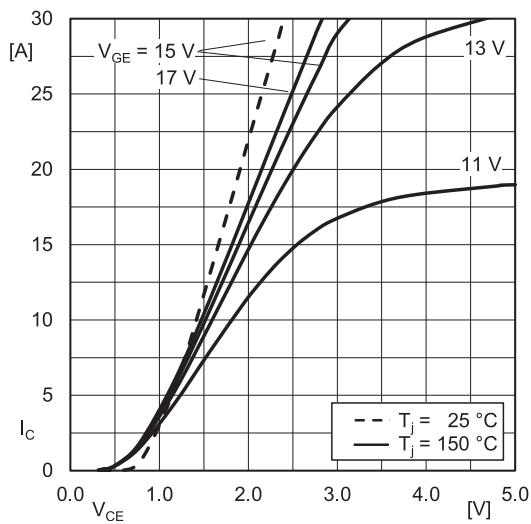

Fig. 1: Typ. IGBT output characteristic, incl. $R_{CC+EE'}$

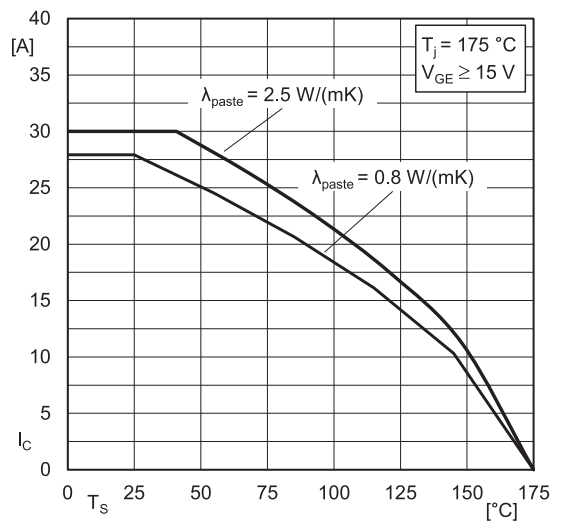

Fig. 2: IGBT rated current vs. temperature $I_c=f(T_s)$

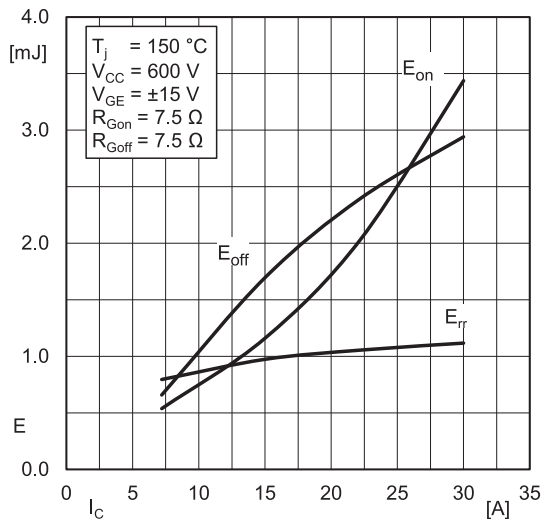

Fig. 3: Typ. turn-on /-off energy = $f(I_c)$

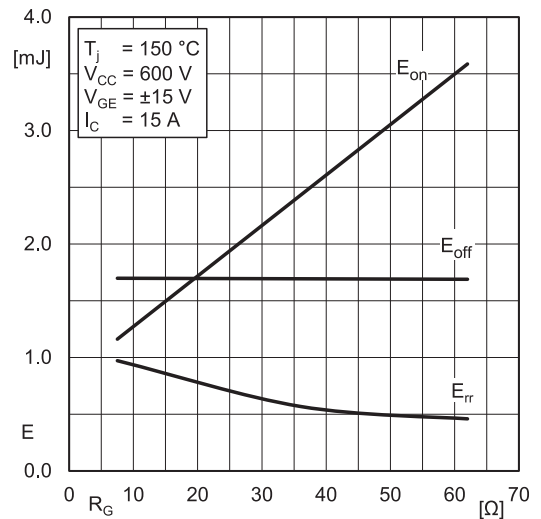

Fig. 4: Typ. turn-on /-off energy = $f(R_G)$

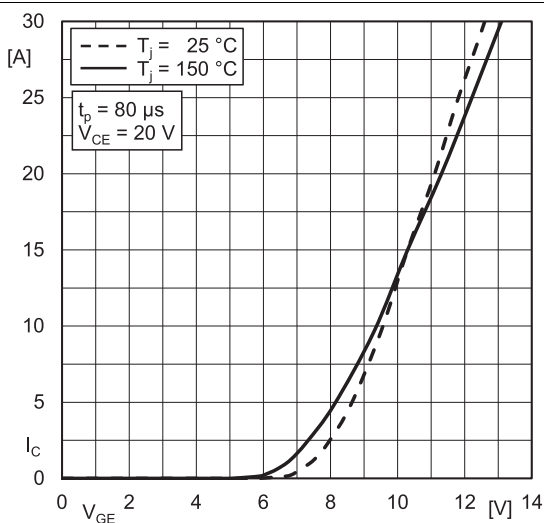

Fig. 5: Typ. IGBT transfer characteristic

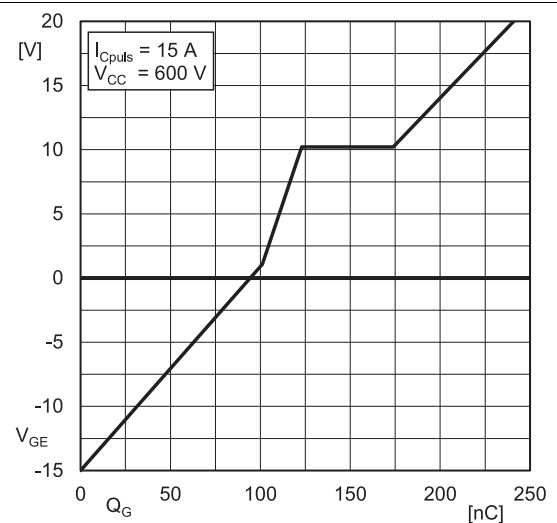

Fig. 6: Typ. IGBT gate charge characteristic

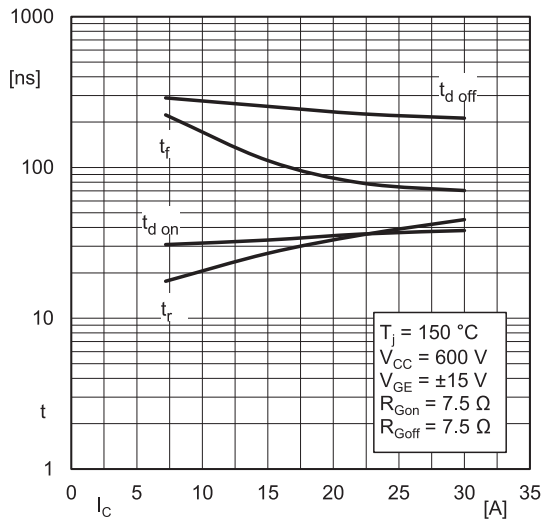

Fig. 7: Typ. switching times = $f(I_C)$

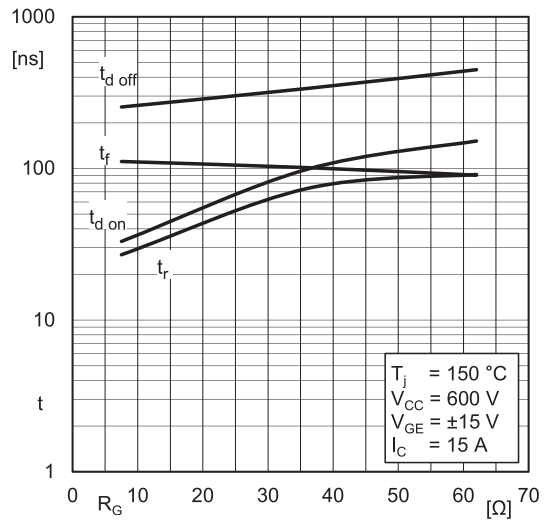

Fig. 8: Typ. switching times = $f(R_G)$

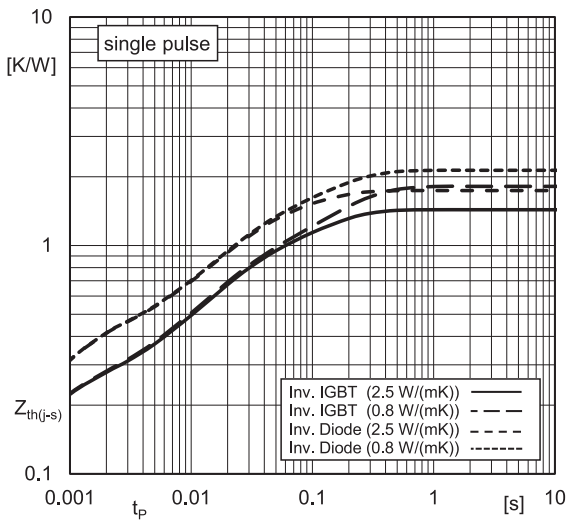

Fig. 9: Typ. transient thermal impedance

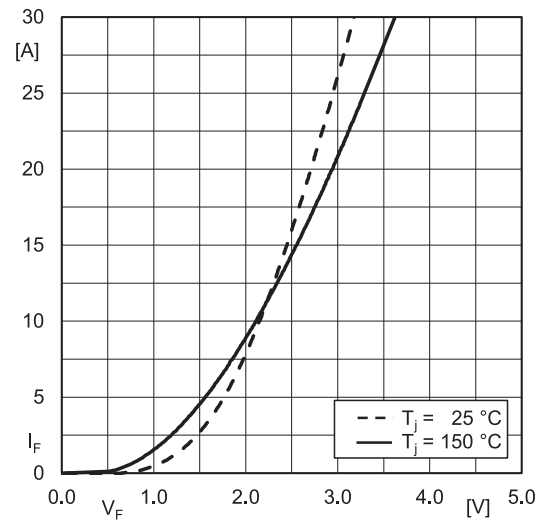

Fig. 10: Typ. Inv. diode forward charact., incl. R_{CC+EE}

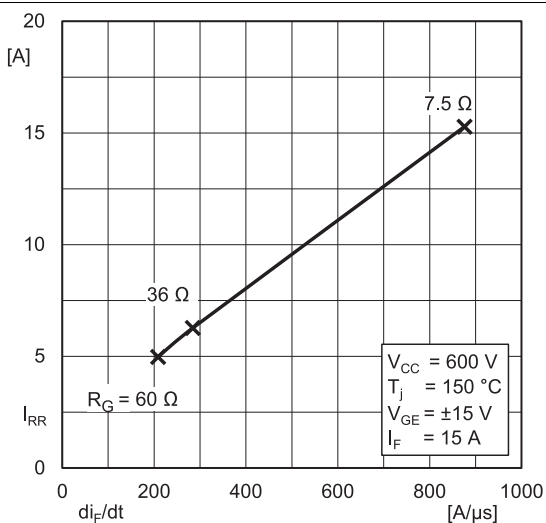

Fig. 11: Typ. Inv. diode peak reverse recovery current

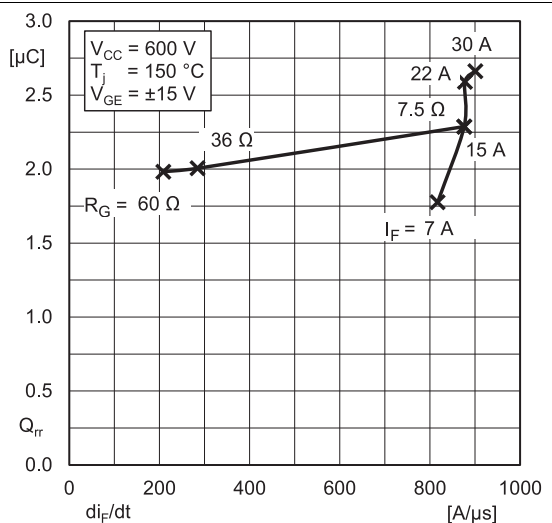

Fig. 12: Typ. Inv. diode reverse recovery charge

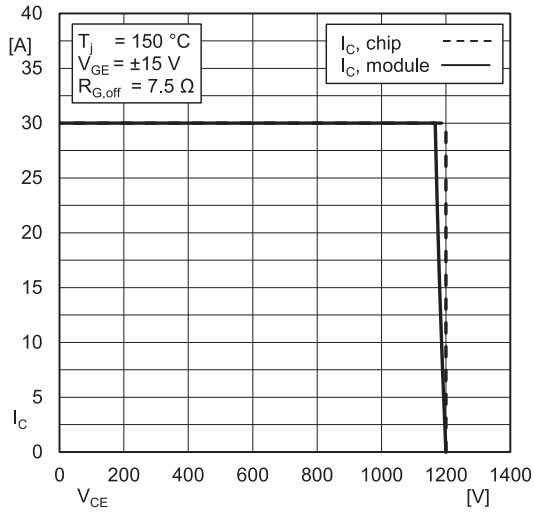

Fig. 13: IGBT Reverse Bias Safe Operating Area (RBSOA)

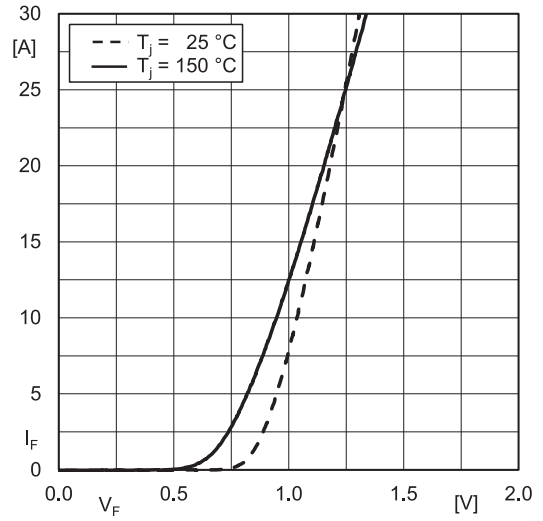
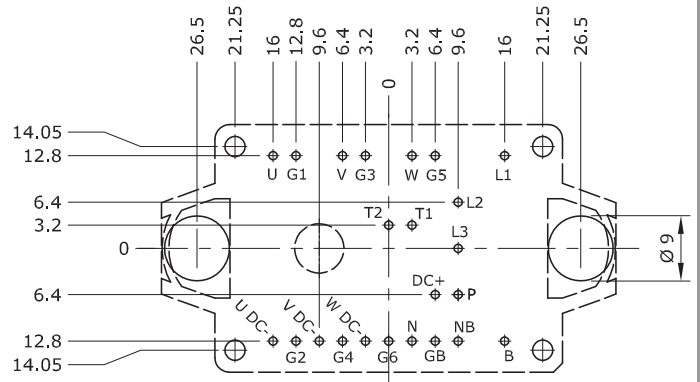
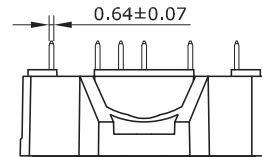
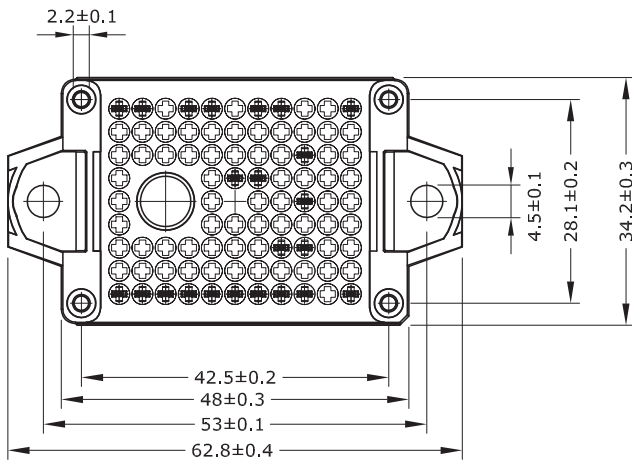
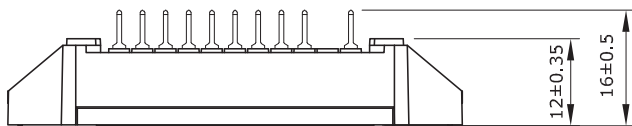

Fig. 14: Typ. Rect. diode forward charact., incl. $R_{CC'+EE'}$

SK15DGDLE12T7ETE1s



- Pin-Grid 3.2 mm
- Tolerance of pinpositions $\boxed{\oplus \ominus \varnothing 0.4}$

SEMITOP®E1 Solder

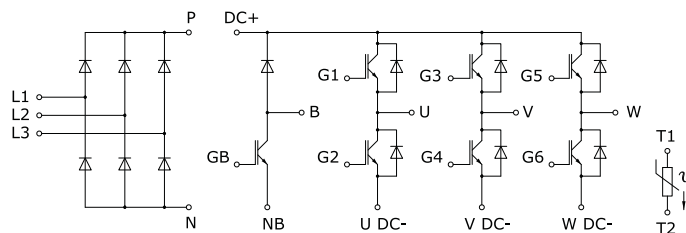

DGDLE12T7

This is an electrostatic discharge sensitive device (ESDS) due to international standard IEC 61340.

***IMPORTANT INFORMATION AND WARNINGS**

The specifications of SEMIKRON products may not be considered as guarantee or assurance of product characteristics ("Beschaffenheitsgarantie"). The specifications of SEMIKRON products describe only the usual characteristics of products to be expected in typical applications, which may still vary depending on the specific application. Therefore, products must be tested for the respective application in advance. Application adjustments may be necessary. The user of SEMIKRON products is responsible for the safety of their applications embedding SEMIKRON products and must take adequate safety measures to prevent the applications from causing a physical injury, fire or other problem if any of SEMIKRON products become faulty. The user is responsible to make sure that the application design is compliant with all applicable laws, regulations, norms and standards. Except as otherwise explicitly approved by SEMIKRON in a written document signed by authorized representatives of SEMIKRON, SEMIKRON products may not be used in any applications where a failure of the product or any consequences of the use thereof can reasonably be expected to result in personal injury. No representation or warranty is given and no liability is assumed with respect to the accuracy, completeness and/or use of any information herein, including without limitation, warranties of non-infringement of intellectual property rights of any third party. SEMIKRON does not assume any liability arising out of the applications or use of any product; neither does it convey any license under its patent rights, copyrights, trade secrets or other intellectual property rights, nor the rights of others. SEMIKRON makes no representation or warranty of non-infringement or alleged non-infringement of intellectual property rights of any third party which may arise from applications. Due to technical requirements our products may contain dangerous substances. For information on the types in question please contact the nearest SEMIKRON sales office. This document supersedes and replaces all information previously supplied and may be superseded by updates. SEMIKRON reserves the right to make changes.