

SEMITOP®E1

Sixpack Open Emitter

SK25GD12T7ETE1

Features*

- Optimized design for superior thermal performance
- Low inductive design
- Press-Fit contact technology
- 1200V Generation 7 IGBT (T7)
- Robust and soft switching CAL4F diode technology
- Integrated NTC temperature sensor
- UL recognized file no. E 63 532

Typical Applications

- Motor drives
- Servo drives
- Air conditioning
- Auxiliary Inverters
- UPS

Remarks

- Recommended $T_{j,op} = -40 \dots +150 \text{ }^\circ\text{C}$
- $T_{j,op} > 150 \text{ }^\circ\text{C}$ during overload (details on AN19-002)

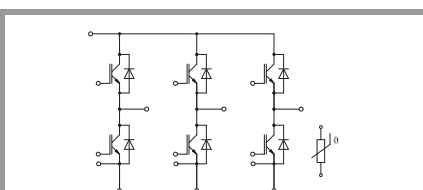

GD-ET

Absolute Maximum Ratings				
Symbol	Conditions		Values	Unit
Inverter - IGBT				
V_{CES}	$T_j = 25 \text{ }^\circ\text{C}$		1200	V
I_C	$\lambda_{paste}=0.8 \text{ W/(mK)}$	$T_s = 70 \text{ }^\circ\text{C}$	33	A
		$T_j = 175 \text{ }^\circ\text{C}$	27	A
I_C	$\lambda_{paste}=2.5 \text{ W/(mK)}$	$T_s = 70 \text{ }^\circ\text{C}$	38	A
		$T_j = 175 \text{ }^\circ\text{C}$	31	A
I_{Cnom}			25	A
I_{CRM}			50	A
V_{GES}			-20 ... 20	V
t_{psc}	$V_{CC} = 800 \text{ V}$	$T_j = 175 \text{ }^\circ\text{C}$	7	μs
	$V_{GE} \leq 15 \text{ V}$ $V_{CES} \leq 1200 \text{ V}$			
T_j			-40 ... 175	$^\circ\text{C}$
Inverse - Diode				
V_{RRM}	$T_j = 25 \text{ }^\circ\text{C}$		1200	V
I_F	$\lambda_{paste}=0.8 \text{ W/(mK)}$	$T_s = 70 \text{ }^\circ\text{C}$	24	A
		$T_j = 175 \text{ }^\circ\text{C}$	20	A
I_F	$\lambda_{paste}=2.5 \text{ W/(mK)}$	$T_s = 70 \text{ }^\circ\text{C}$	28	A
		$T_j = 175 \text{ }^\circ\text{C}$	23	A
I_{FRM}			50	A
I_{FSM}	$t_p = 10 \text{ ms, sin } 180^\circ, T_j = 150 \text{ }^\circ\text{C}$		100	A
T_j			-40 ... 175	$^\circ\text{C}$
Module				
$I_{t(RMS)}$, $\Delta T_{terminal}$ at PCB joint = 30 K, per pin		30	A
T_{stg}	module without TIM		-40 ... 125	$^\circ\text{C}$
V_{isol}	AC, sinusoidal, $t = 1 \text{ min}$		2500	V

Characteristics						
Symbol	Conditions	min.	typ.	max.	Unit	
Inverter - IGBT						
$V_{CE(sat)}$	$I_C = 25 \text{ A}$ $V_{GE} = 15 \text{ V}$ chipelevel	$T_j = 25 \text{ }^\circ\text{C}$	1.60	1.75	V	
		$T_j = 150 \text{ }^\circ\text{C}$	1.78	1.93	V	
		$T_j = 175 \text{ }^\circ\text{C}$	1.82	1.97	V	
V_{CE0}	chipelevel	$T_j = 25 \text{ }^\circ\text{C}$	1.00	1.05	V	
		$T_j = 150 \text{ }^\circ\text{C}$	0.80	0.85	V	
		$T_j = 175 \text{ }^\circ\text{C}$	0.75	0.80	V	
r_{CE}	$V_{GE} = 15 \text{ V}$ chipelevel	$T_j = 25 \text{ }^\circ\text{C}$	24	28	m Ω	
		$T_j = 150 \text{ }^\circ\text{C}$	39	43	m Ω	
		$T_j = 175 \text{ }^\circ\text{C}$	43	47	m Ω	
$V_{GE(th)}$	$V_{GE} = V_{CE}, I_C = 0.53 \text{ mA}$		5.15	5.8	6.45	V
I_{CES}	$V_{GE} = 0 \text{ V}, V_{CE} = 1200 \text{ V}, T_j = 25 \text{ }^\circ\text{C}$			1	mA	
C_{ies}	$V_{CE} = 25 \text{ V}$ $V_{GE} = 0 \text{ V}$	$f = 1 \text{ MHz}$	4.80		nF	
C_{oes}		$f = 1 \text{ MHz}$	0.06		nF	
C_{res}		$f = 1 \text{ MHz}$	0.02		nF	
Q_G	$V_{GE} = -15 \text{ V} \dots +15 \text{ V}$		354		nC	
R_{Gint}	$T_j = 25 \text{ }^\circ\text{C}$		0		Ω	



SEMITOP®E1

Sixpack Open Emitter

SK25GD12T7ETE1

Features*

- Optimized design for superior thermal performance
- Low inductive design
- Press-Fit contact technology
- 1200V Generation 7 IGBT (T7)
- Robust and soft switching CAL4F diode technology
- Integrated NTC temperature sensor
- UL recognized file no. E 63 532

Typical Applications

- Motor drives
- Servo drives
- Air conditioning
- Auxiliary Inverters
- UPS

Remarks

- Recommended $T_{j,op} = -40 \dots +150 \text{ }^\circ\text{C}$
- $T_{j,op} > 150 \text{ }^\circ\text{C}$ during overload (details on AN19-002)

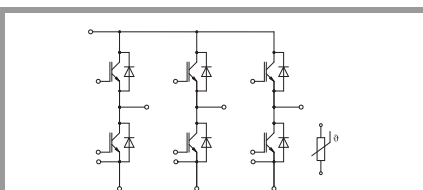

GD-ET

Characteristics						
Symbol	Conditions		min.	typ.	max.	Unit
Inverter - IGBT						
$t_{d(on)}$		$T_j = 25 \text{ }^\circ\text{C}$		28		ns
		$T_j = 150 \text{ }^\circ\text{C}$		30		ns
		$T_j = 175 \text{ }^\circ\text{C}$		32		ns
t_r		$T_j = 25 \text{ }^\circ\text{C}$		23		ns
		$T_j = 150 \text{ }^\circ\text{C}$		25		ns
		$T_j = 175 \text{ }^\circ\text{C}$		26		ns
E_{on}	$V_{CC} = 600 \text{ V}$ $I_C = 25 \text{ A}$ $R_{G on} = 6.2 \text{ } \Omega$ $R_{G off} = 6.2 \text{ } \Omega$ $V_{GE} = +15/-15 \text{ V}$	$T_j = 25 \text{ }^\circ\text{C}$		1.65		mJ
		$T_j = 150 \text{ }^\circ\text{C}$		2.42		mJ
		$T_j = 175 \text{ }^\circ\text{C}$		2.72		mJ
		$T_j = 25 \text{ }^\circ\text{C}$		191		ns
$t_{d(off)}$	$(T_j = 150 \text{ }^\circ\text{C})$ $di/dt_{on} = 880 \text{ A}/\mu\text{s}$ $di/dt_{off} = 210 \text{ A}/\mu\text{s}$	$T_j = 25 \text{ }^\circ\text{C}$		231		ns
		$T_j = 150 \text{ }^\circ\text{C}$		251		ns
		$T_j = 175 \text{ }^\circ\text{C}$		251		ns
t_f	$dv/dt = 5400 \text{ V}/\mu\text{s}$	$T_j = 25 \text{ }^\circ\text{C}$		66		ns
		$T_j = 150 \text{ }^\circ\text{C}$		101		ns
		$T_j = 175 \text{ }^\circ\text{C}$		108		ns
E_{off}		$T_j = 25 \text{ }^\circ\text{C}$		2.04		mJ
		$T_j = 150 \text{ }^\circ\text{C}$		2.71		mJ
		$T_j = 175 \text{ }^\circ\text{C}$		3.09		mJ
$R_{th(j-s)}$	per IGBT, $\lambda_{paste}=0.8 \text{ W}/(\text{mK})$		1.32			K/W
$R_{th(j-s)}$	per IGBT, $\lambda_{paste}=2.5 \text{ W}/(\text{mK})$		1.06			K/W

Characteristics						
Symbol	Conditions		min.	typ.	max.	Unit
Inverse - Diode						
$V_F = V_{EC}$	$I_F = 25 \text{ A}$	$T_j = 25 \text{ }^\circ\text{C}$		2.41	2.74	V
		$T_j = 150 \text{ }^\circ\text{C}$		2.45	2.79	V
		chiplevel $T_j = 175 \text{ }^\circ\text{C}$		2.30	2.62	V
V_{F0}	chiplevel	$T_j = 25 \text{ }^\circ\text{C}$		1.30	1.50	V
		$T_j = 150 \text{ }^\circ\text{C}$		0.90	1.10	V
		$T_j = 175 \text{ }^\circ\text{C}$		0.82	0.98	V
r_F	chiplevel	$T_j = 25 \text{ }^\circ\text{C}$		44	50	m Ω
		$T_j = 150 \text{ }^\circ\text{C}$		62	68	m Ω
		$T_j = 175 \text{ }^\circ\text{C}$		59	66	m Ω
I_{RRM}		$T_j = 25 \text{ }^\circ\text{C}$		20		A
		$T_j = 150 \text{ }^\circ\text{C}$		28		A
		$T_j = 175 \text{ }^\circ\text{C}$		30		A
Q_{rr}	$I_F = 25 \text{ A}$ $V_{GE} = +15/-15 \text{ V}$ $V_{CC} = 600 \text{ V}$ $(T_j = 150 \text{ }^\circ\text{C})$	$T_j = 25 \text{ }^\circ\text{C}$		1.41		μC
		$T_j = 150 \text{ }^\circ\text{C}$		3.71		μC
		$T_j = 175 \text{ }^\circ\text{C}$		4.19		μC
E_{rr}	$di/dt_{off} = 1050 \text{ A}/\mu\text{s}$	$T_j = 25 \text{ }^\circ\text{C}$		0.51		mJ
		$T_j = 150 \text{ }^\circ\text{C}$		1.61		mJ
		$T_j = 175 \text{ }^\circ\text{C}$		2.46		mJ
$R_{th(j-s)}$	per Diode, $\lambda_{paste}=0.8 \text{ W}/(\text{mK})$		1.66			K/W
$R_{th(j-s)}$	per Diode, $\lambda_{paste}=2.5 \text{ W}/(\text{mK})$		1.29			K/W

Module						
L_{CE}				30		nH
M_s	to heatsink		1.6		2.3	Nm
w				25		g

SK25GD12T7ETE1

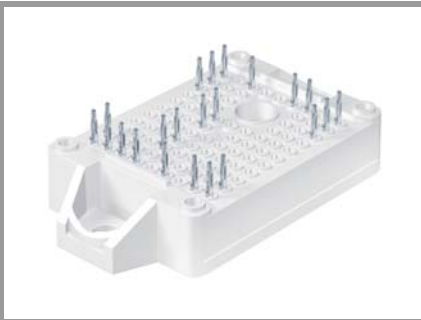

SEMITOP®E1

Characteristics					
Symbol	Conditions	min.	typ.	max.	Unit
Temperature Sensor					
R ₁₀₀	T _c =100°C (R ₂₅ =5 kΩ)		493 ± 5%		Ω
B _{25/85}	R _(T) =R ₂₅ *exp[B _{25/85} *(1/T-1/298)], T[K]		3420		K

Sixpack Open Emitter

SK25GD12T7ETE1

Features*

- Optimized design for superior thermal performance
- Low inductive design
- Press-Fit contact technology
- 1200V Generation 7 IGBT (T7)
- Robust and soft switching CAL4F diode technology
- Integrated NTC temperature sensor
- UL recognized file no. E 63 532

Typical Applications

- Motor drives
- Servo drives
- Air conditioning
- Auxiliary Inverters
- UPS

Remarks

- Recommended T_{j,op} = -40 ...+150 °C
- T_{j,op} > 150 °C during overload (details on AN19-002)

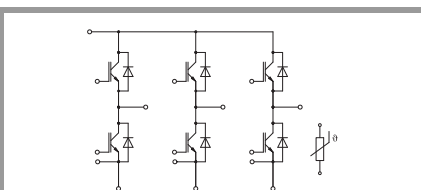

GD-ET

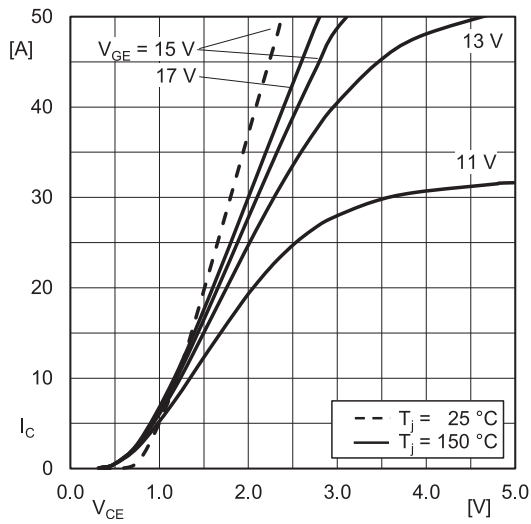

Fig. 1: Typ. IGBT output characteristic, incl. $R_{CC+EE'}$

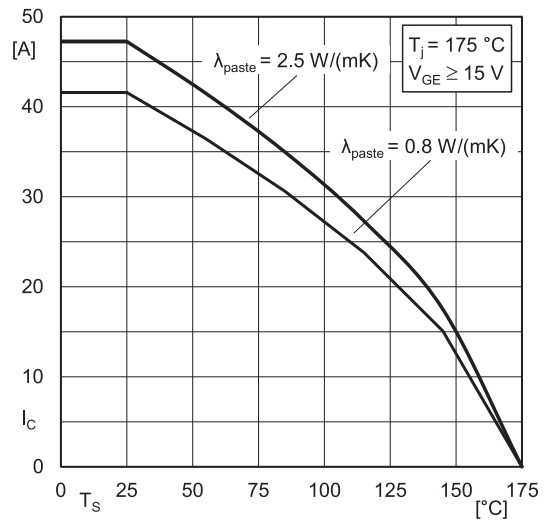

Fig. 2: IGBT rated current vs. temperature $I_C=f(T_s)$

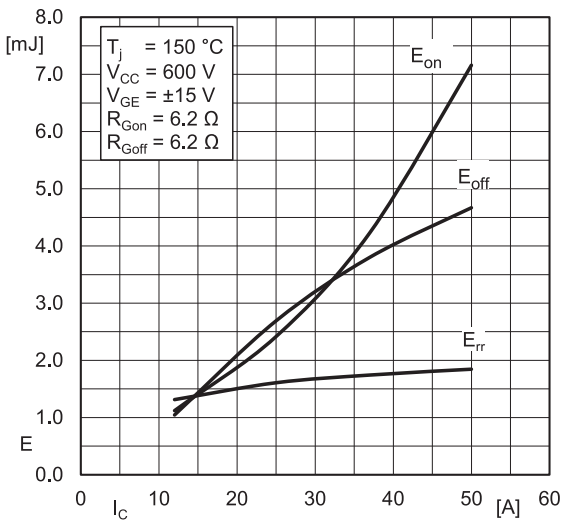

Fig. 3: Typ. turn-on /-off energy = $f(I_C)$

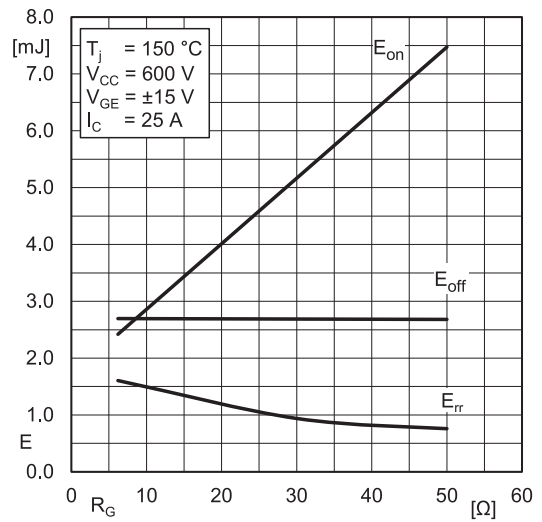

Fig. 4: Typ. turn-on /-off energy = $f(R_G)$

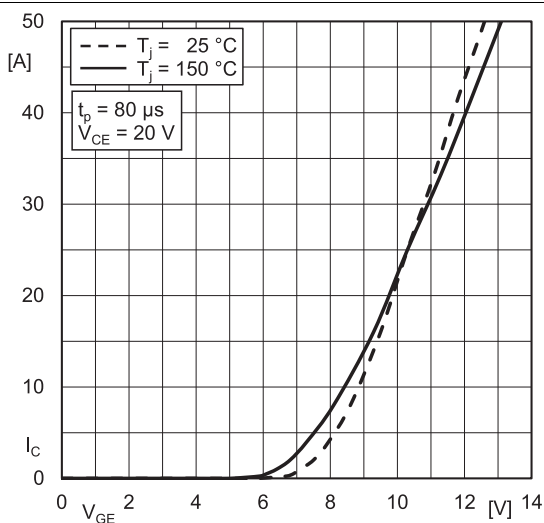

Fig. 5: Typ. IGBT transfer characteristic

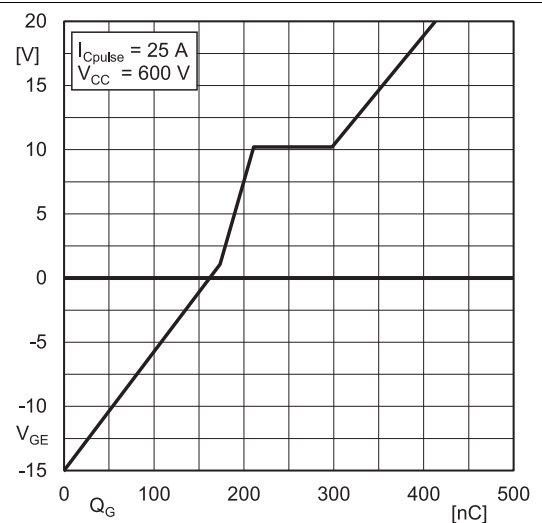

Fig. 6: Typ. IGBT gate charge characteristic

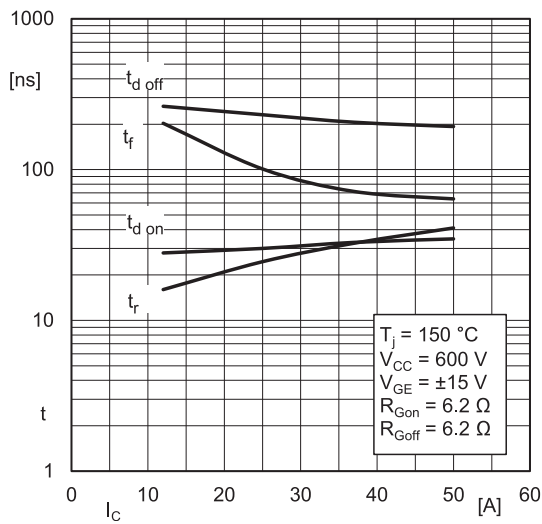

Fig. 7: Typ. switching times = $f(I_C)$

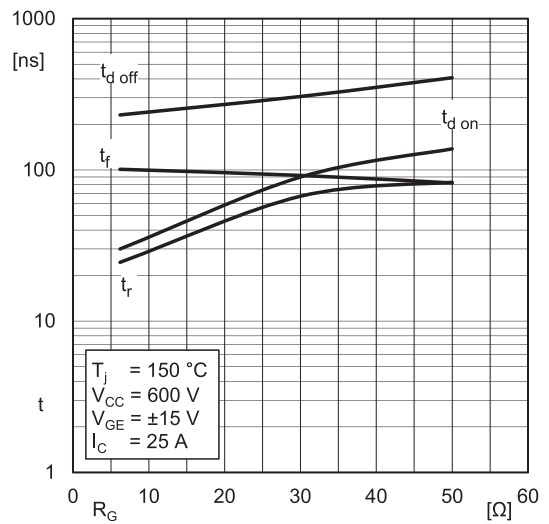

Fig. 8: Typ. switching times = $f(R_G)$

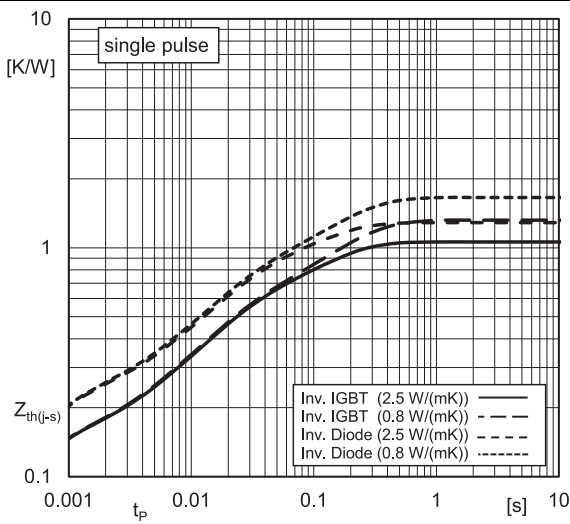

Fig. 9: Typ. transient thermal impedance

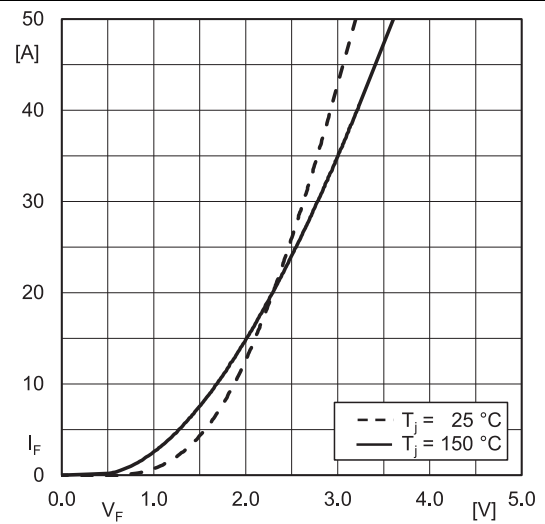

Fig. 10: Typ. Inv. diode forward charact., incl. $R_{CC+EE'}$

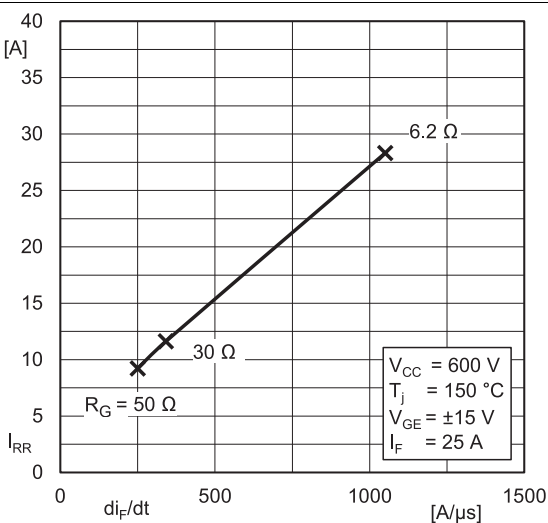

Fig. 11: Typ. Inv. diode peak reverse recovery current

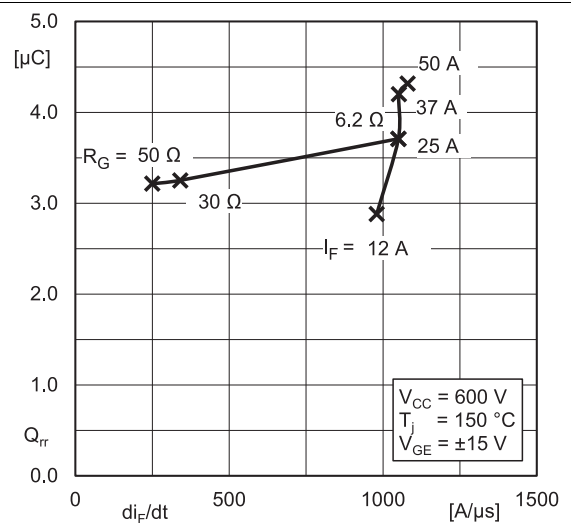

Fig. 12: Typ. Inv. diode reverse recovery charge

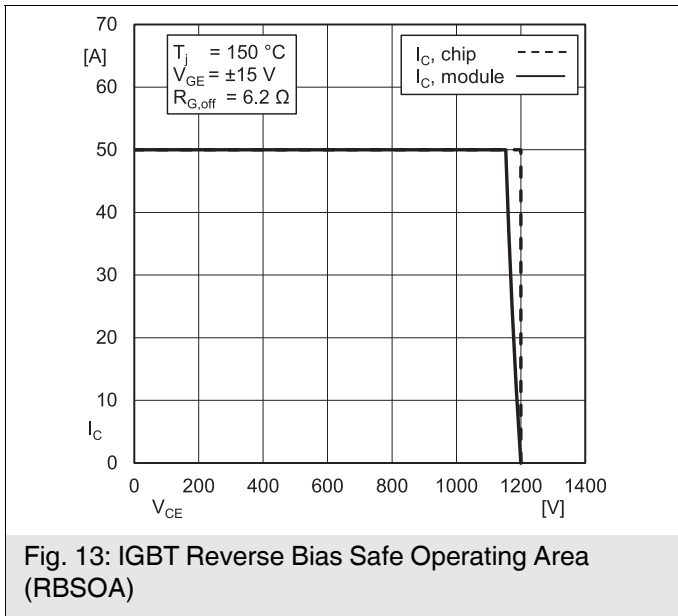
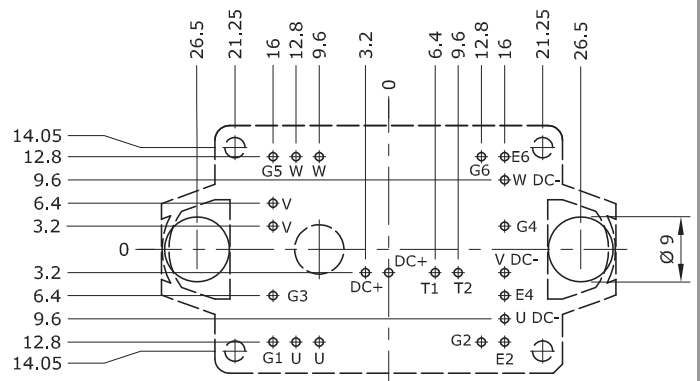
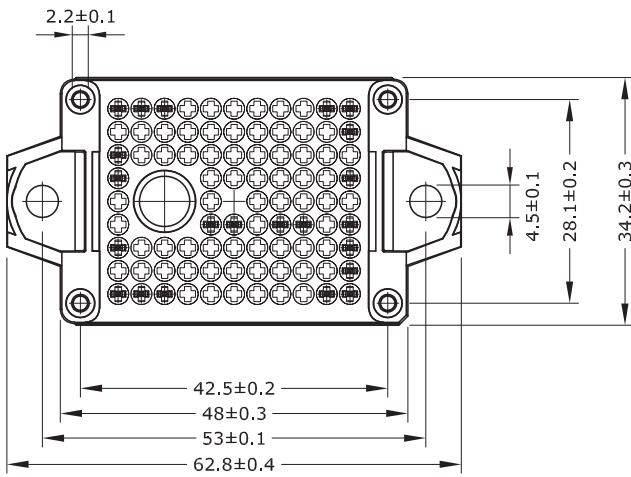
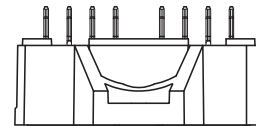
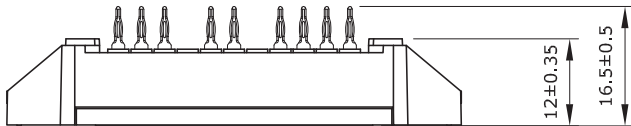

Fig. 13: IGBT Reverse Bias Safe Operating Area (RBSOA)

SK25GD12T7ETE1



- Pin-Grid 3.2 mm
- Tolerance of PCB hole pattern $\text{⌀} \pm 0.1$
- Diameters of drill $\text{⌀} 1.15\text{mm}$
- Copper thickness in hole 25 - 50 μm
- Hole specification for contacts:
refer to SEMITOP E1/E2 Mounting Instruction

SEMITOP®E1

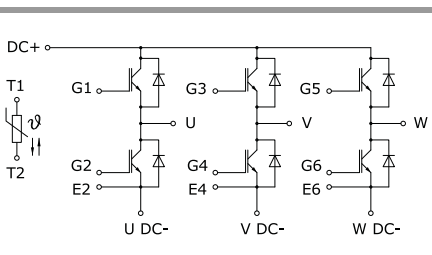

GD-ET

This is an electrostatic discharge sensitive device (ESDS) due to international standard IEC 61340.

***IMPORTANT INFORMATION AND WARNINGS**

The specifications of SEMIKRON products may not be considered as guarantee or assurance of product characteristics ("Beschaffenheitsgarantie"). The specifications of SEMIKRON products describe only the usual characteristics of products to be expected in typical applications, which may still vary depending on the specific application. Therefore, products must be tested for the respective application in advance. Application adjustments may be necessary. The user of SEMIKRON products is responsible for the safety of their applications embedding SEMIKRON products and must take adequate safety measures to prevent the applications from causing a physical injury, fire or other problem if any of SEMIKRON products become faulty. The user is responsible to make sure that the application design is compliant with all applicable laws, regulations, norms and standards. Except as otherwise explicitly approved by SEMIKRON in a written document signed by authorized representatives of SEMIKRON, SEMIKRON products may not be used in any applications where a failure of the product or any consequences of the use thereof can reasonably be expected to result in personal injury. No representation or warranty is given and no liability is assumed with respect to the accuracy, completeness and/or use of any information herein, including without limitation, warranties of non-infringement of intellectual property rights of any third party. SEMIKRON does not assume any liability arising out of the applications or use of any product; neither does it convey any license under its patent rights, copyrights, trade secrets or other intellectual property rights, nor the rights of others. SEMIKRON makes no representation or warranty of non-infringement or alleged non-infringement of intellectual property rights of any third party which may arise from applications. Due to technical requirements our products may contain dangerous substances. For information on the types in question please contact the nearest SEMIKRON sales office. This document supersedes and replaces all information previously supplied and may be superseded by updates. SEMIKRON reserves the right to make changes.