

**SEMITOP®E2**

## Sixpack Open Emitter

### SK75GD12T7ETE2

#### Features\*

- Optimized design for superior thermal performance
- Low inductive design
- Press-Fit contact technology
- 1200V Generation 7 IGBT (T7)
- Robust and soft switching CAL4F diode technology
- Integrated NTC temperature sensor
- UL recognized file no. E 63 532

#### Typical Applications

- Motor drives
- Servo drives
- Air conditioning
- Auxiliary Inverters
- UPS

#### Remarks

- Recommended  $T_{j,op} = -40 \dots +150 \text{ }^\circ\text{C}$
- $T_{j,op} > 150 \text{ }^\circ\text{C}$  during overload (details on AN19-002)

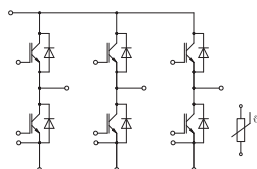

**GD-ET**

Absolute Maximum Ratings				
Symbol	Conditions		Values	Unit
<b>Inverter - IGBT</b>				
$V_{CES}$	$T_j = 25 \text{ }^\circ\text{C}$		1200	V
$I_C$	$\lambda_{paste}=0.8 \text{ W/(mK)}$	$T_s = 70 \text{ }^\circ\text{C}$	75	A
		$T_j = 175 \text{ }^\circ\text{C}$	60	A
$I_C$	$\lambda_{paste}=2.5 \text{ W/(mK)}$	$T_s = 70 \text{ }^\circ\text{C}$	96	A
		$T_s = 100 \text{ }^\circ\text{C}$	78	A
$I_{Cnom}$			75	A
$I_{CRM}$			150	A
$V_{GES}$			-20 ... 20	V
$t_{psc}$	$V_{CC} = 800 \text{ V}$ $V_{GE} \leq 15 \text{ V}$ $V_{CES} \leq 1200 \text{ V}$	$T_j = 175 \text{ }^\circ\text{C}$	7	$\mu\text{s}$
$T_j$			-40 ... 175	$^\circ\text{C}$
<b>Inverse - Diode</b>				
$V_{RRM}$	$T_j = 25 \text{ }^\circ\text{C}$		1200	V
$I_F$	$\lambda_{paste}=0.8 \text{ W/(mK)}$	$T_s = 70 \text{ }^\circ\text{C}$	63	A
		$T_j = 175 \text{ }^\circ\text{C}$	50	A
$I_F$	$\lambda_{paste}=2.5 \text{ W/(mK)}$	$T_s = 70 \text{ }^\circ\text{C}$	81	A
		$T_s = 100 \text{ }^\circ\text{C}$	65	A
$I_{FRM}$			150	A
$I_{FSM}$	$t_p = 10 \text{ ms, sin } 180^\circ, T_j = 150 \text{ }^\circ\text{C}$		430	A
$T_j$			-40 ... 175	$^\circ\text{C}$
<b>Module</b>				
$I_{t(RMS)}$	, $\Delta T_{terminal}$ at PCB joint = 30 K, per pin		30	A
$T_{stg}$	module without TIM		-40 ... 125	$^\circ\text{C}$
$V_{isol}$	AC, sinusoidal, $t = 1 \text{ min}$		2500	V

Characteristics						
Symbol	Conditions		min.	typ.	max.	Unit
<b>Inverter - IGBT</b>						
$V_{CE(sat)}$	$I_C = 75 \text{ A}$ $V_{GE} = 15 \text{ V}$ chipelevel	$T_j = 25 \text{ }^\circ\text{C}$	1.55	1.70		V
		$T_j = 150 \text{ }^\circ\text{C}$	1.73	1.88		V
		$T_j = 175 \text{ }^\circ\text{C}$	1.77	1.92		V
$V_{CE0}$	chipelevel	$T_j = 25 \text{ }^\circ\text{C}$	1.00	1.05		V
		$T_j = 150 \text{ }^\circ\text{C}$	0.80	0.85		V
		$T_j = 175 \text{ }^\circ\text{C}$	0.75	0.80		V
$r_{CE}$	$V_{GE} = 15 \text{ V}$ chipelevel	$T_j = 25 \text{ }^\circ\text{C}$	7.3	8.7		m $\Omega$
		$T_j = 150 \text{ }^\circ\text{C}$	12	14		m $\Omega$
		$T_j = 175 \text{ }^\circ\text{C}$	14	15		m $\Omega$
$V_{GE(th)}$	$V_{GE} = V_{CE}, I_C = 1.7 \text{ mA}$		5.15	5.8	6.45	V
$I_{CES}$	$V_{GE} = 0 \text{ V}, V_{CE} = 1200 \text{ V}, T_j = 25 \text{ }^\circ\text{C}$				1	mA
$C_{ies}$				15.10		nF
$C_{oes}$	$V_{CE} = 25 \text{ V}$ $V_{GE} = 0 \text{ V}$	$f = 1 \text{ MHz}$		0.19		nF
$C_{res}$		$f = 1 \text{ MHz}$		0.54		nF
$Q_G$	$V_{GE} = -15\text{V} \dots +15\text{V}$			1218		nC
$R_{Gint}$	$T_j = 25 \text{ }^\circ\text{C}$			2.0		$\Omega$

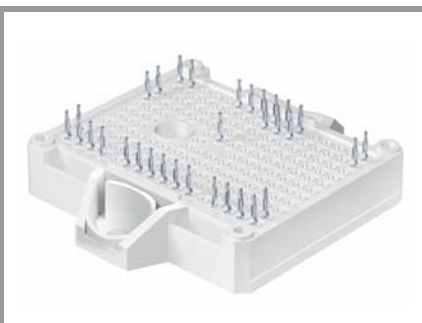

**SEMITOP®E2**

## Sixpack Open Emitter

### SK75GD12T7ETE2

#### Features\*

- Optimized design for superior thermal performance
- Low inductive design
- Press-Fit contact technology
- 1200V Generation 7 IGBT (T7)
- Robust and soft switching CAL4F diode technology
- Integrated NTC temperature sensor
- UL recognized file no. E 63 532

#### Typical Applications

- Motor drives
- Servo drives
- Air conditioning
- Auxiliary Inverters
- UPS

#### Remarks

- Recommended  $T_{j,op} = -40 \dots +150 \text{ }^\circ\text{C}$
- $T_{j,op} > 150 \text{ }^\circ\text{C}$  during overload (details on AN19-002)

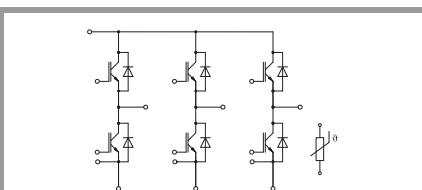

**GD-ET**

Characteristics						
Symbol	Conditions		min.	typ.	max.	Unit
<b>Inverter - IGBT</b>						
$t_{d(on)}$		$T_j = 25 \text{ }^\circ\text{C}$		111		ns
		$T_j = 150 \text{ }^\circ\text{C}$		126		ns
		$T_j = 175 \text{ }^\circ\text{C}$		131		ns
$t_r$		$T_j = 25 \text{ }^\circ\text{C}$		25		ns
		$T_j = 150 \text{ }^\circ\text{C}$		31		ns
		$T_j = 175 \text{ }^\circ\text{C}$		33		ns
$E_{on}$	$V_{CC} = 600 \text{ V}$ $I_C = 75 \text{ A}$ $R_{G on} = 2.2 \text{ } \Omega$ $R_{G off} = 2.2 \text{ } \Omega$ $V_{GE} = +15/-15 \text{ V}$	$T_j = 25 \text{ }^\circ\text{C}$		4.06		mJ
		$T_j = 150 \text{ }^\circ\text{C}$		7.06		mJ
		$T_j = 175 \text{ }^\circ\text{C}$		7.81		mJ
		$T_j = 25 \text{ }^\circ\text{C}$		231		ns
$t_{d(off)}$	$(T_j = 150 \text{ }^\circ\text{C})$ $di/dt_{on} = 2400 \text{ A}/\mu\text{s}$ $di/dt_{off} = 700 \text{ A}/\mu\text{s}$	$T_j = 150 \text{ }^\circ\text{C}$		307		ns
		$T_j = 175 \text{ }^\circ\text{C}$		325		ns
		$T_j = 25 \text{ }^\circ\text{C}$		49		ns
$t_f$	$dv/dt = 4000 \text{ V}/\mu\text{s}$	$T_j = 150 \text{ }^\circ\text{C}$		73		ns
		$T_j = 175 \text{ }^\circ\text{C}$		76		ns
		$T_j = 25 \text{ }^\circ\text{C}$		4.62		mJ
$E_{off}$		$T_j = 150 \text{ }^\circ\text{C}$		7.85		mJ
		$T_j = 175 \text{ }^\circ\text{C}$		8.65		mJ
		$T_j = 25 \text{ }^\circ\text{C}$		0.73		K/W
$R_{th(j-s)}$	per IGBT, $\lambda_{paste} = 0.8 \text{ W}/(\text{mK})$					K/W
$R_{th(j-s)}$	per IGBT, $\lambda_{paste} = 2.5 \text{ W}/(\text{mK})$					K/W

Characteristics						
Symbol	Conditions		min.	typ.	max.	Unit
<b>Inverse - Diode</b>						
$V_F = V_{EC}$	$I_F = 75 \text{ A}$	$T_j = 25 \text{ }^\circ\text{C}$		2.17	2.49	V
		$T_j = 150 \text{ }^\circ\text{C}$		2.11	2.42	V
		chiplevel	$T_j = 175 \text{ }^\circ\text{C}$		1.96	2.27
$V_{F0}$	chiplevel	$T_j = 25 \text{ }^\circ\text{C}$		1.30	1.50	V
		$T_j = 150 \text{ }^\circ\text{C}$		0.90	1.10	V
		$T_j = 175 \text{ }^\circ\text{C}$		0.82	0.98	V
$r_F$	chiplevel	$T_j = 25 \text{ }^\circ\text{C}$		12	13	m $\Omega$
		$T_j = 150 \text{ }^\circ\text{C}$		16	18	m $\Omega$
		$T_j = 175 \text{ }^\circ\text{C}$		15	17	m $\Omega$
$I_{RRM}$		$T_j = 25 \text{ }^\circ\text{C}$		97		A
		$T_j = 150 \text{ }^\circ\text{C}$		136		A
		$T_j = 175 \text{ }^\circ\text{C}$		143		A
$Q_{rr}$	$I_F = 75 \text{ A}$ $V_{GE} = +15/-15 \text{ V}$ $V_{CC} = 600 \text{ V}$ $(T_j = 150 \text{ }^\circ\text{C})$	$T_j = 25 \text{ }^\circ\text{C}$		5.54		$\mu\text{C}$
		$T_j = 150 \text{ }^\circ\text{C}$		13.97		$\mu\text{C}$
		$T_j = 175 \text{ }^\circ\text{C}$		16.11		$\mu\text{C}$
$E_{rr}$	$di/dt_{off} = 2600 \text{ A}/\mu\text{s}$	$T_j = 25 \text{ }^\circ\text{C}$		2.48		mJ
		$T_j = 150 \text{ }^\circ\text{C}$		6.44		mJ
		$T_j = 175 \text{ }^\circ\text{C}$		7.35		mJ
$R_{th(j-s)}$	per Diode, $\lambda_{paste} = 0.8 \text{ W}/(\text{mK})$			0.82		K/W
$R_{th(j-s)}$	per Diode, $\lambda_{paste} = 2.5 \text{ W}/(\text{mK})$			0.55		K/W

Module						
$L_{CE}$				40		nH
$M_s$	to heatsink		1.6		2.3	Nm
w				35		g

# SK75GD12T7ETE2

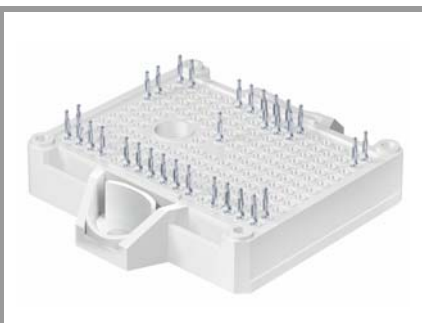

SEMITOP®E2

Characteristics					
Symbol	Conditions	min.	typ.	max.	Unit
<b>Temperature Sensor</b>					
R <sub>100</sub>	T <sub>c</sub> =100°C (R <sub>25</sub> =5 kΩ)		493 ± 5%		Ω
B <sub>25/85</sub>	R <sub>(T)</sub> =R <sub>25</sub> *exp[B <sub>25/85</sub> *(1/T-1/298)], T[K]		3420		K

## Sixpack Open Emitter

### SK75GD12T7ETE2

#### Features\*

- Optimized design for superior thermal performance
- Low inductive design
- Press-Fit contact technology
- 1200V Generation 7 IGBT (T7)
- Robust and soft switching CAL4F diode technology
- Integrated NTC temperature sensor
- UL recognized file no. E 63 532

#### Typical Applications

- Motor drives
- Servo drives
- Air conditioning
- Auxiliary Inverters
- UPS

#### Remarks

- Recommended T<sub>j,op</sub> = -40 ...+150 °C
- T<sub>j,op</sub> > 150 °C during overload (details on AN19-002)

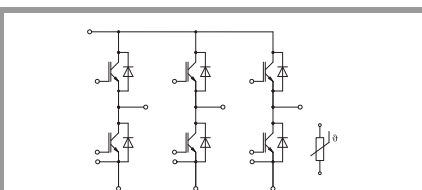

GD-ET

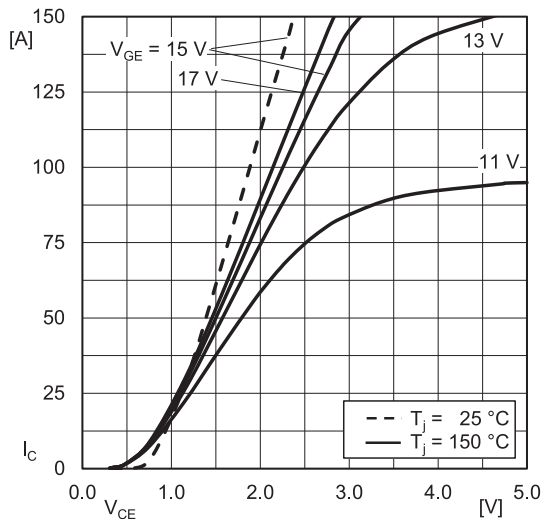

Fig. 1: Typ. IGBT output characteristic, incl.  $R_{CC+EE'}$

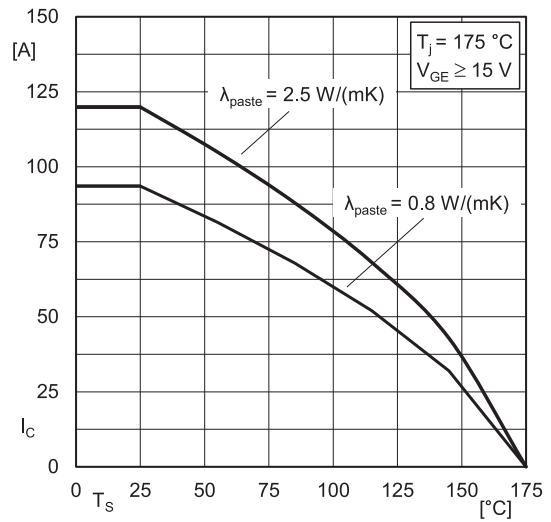

Fig. 2: IGBT rated current vs. temperature  $I_c=f(T_s)$

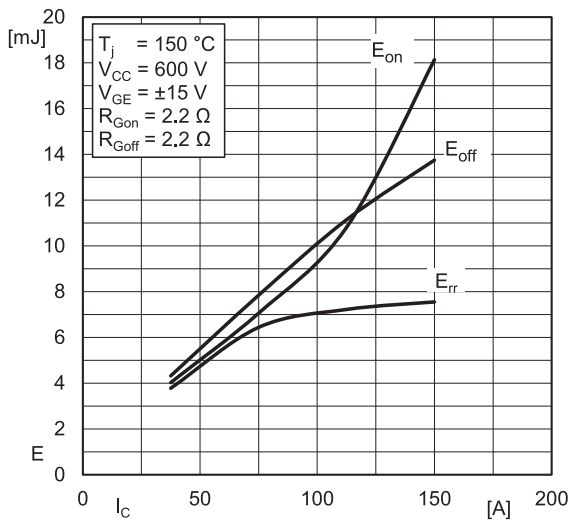

Fig. 3: Typ. turn-on /-off energy =  $f(I_c)$

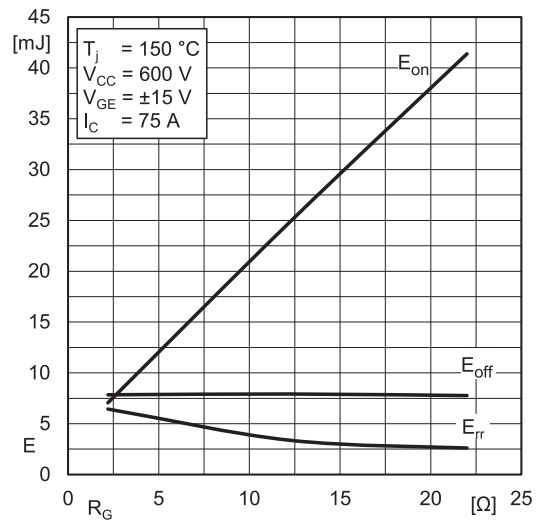

Fig. 4: Typ. turn-on /-off energy =  $f(R_G)$

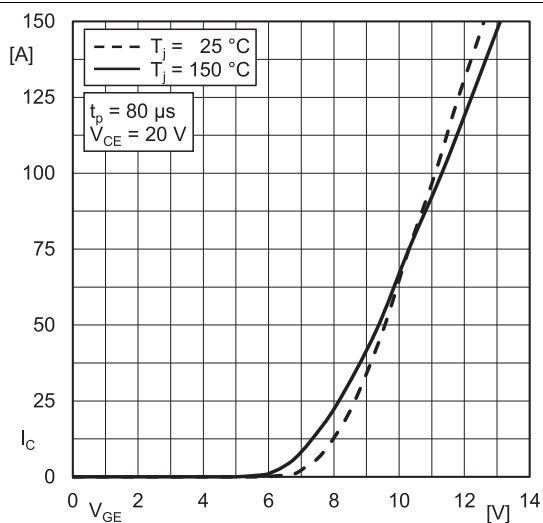

Fig. 5: Typ. IGBT transfer characteristic

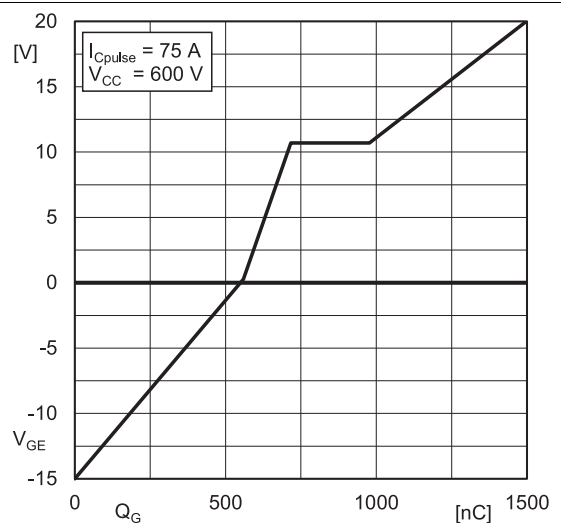

Fig. 6: Typ. IGBT gate charge characteristic

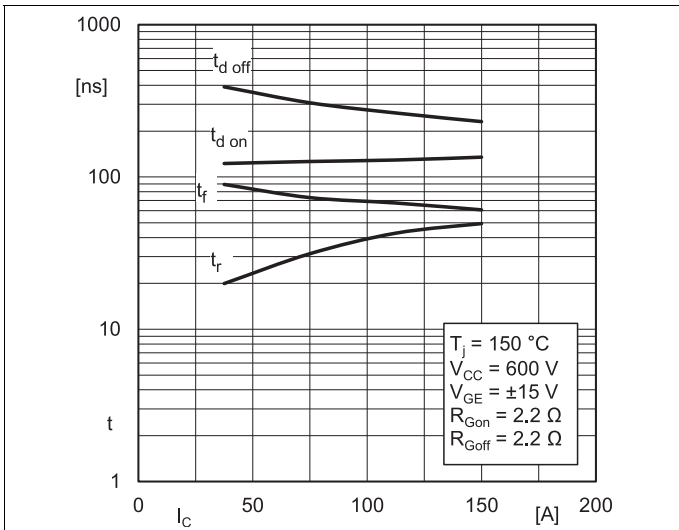

Fig. 7: Typ. switching times =  $f(I_C)$

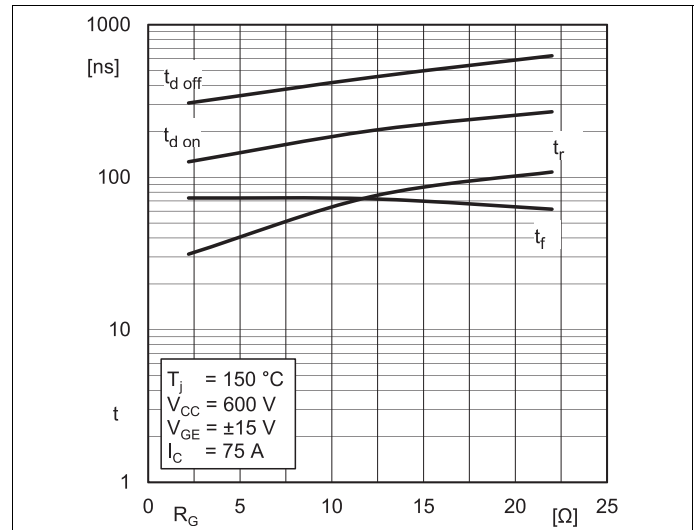

Fig. 8: Typ. switching times =  $f(R_G)$

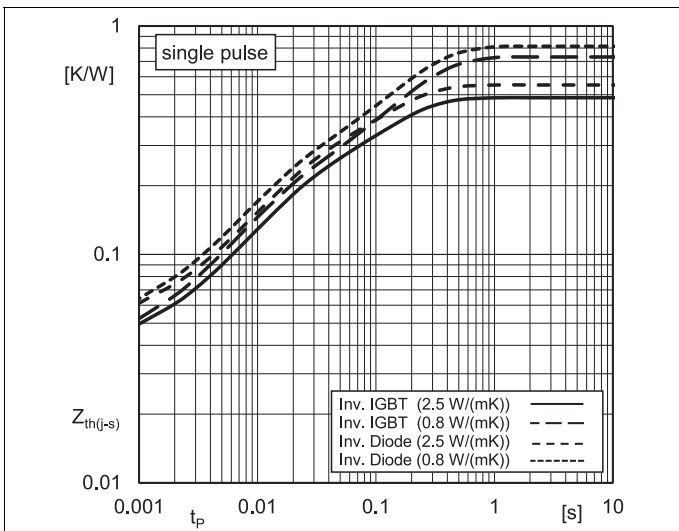

Fig. 9: Typ. transient thermal impedance

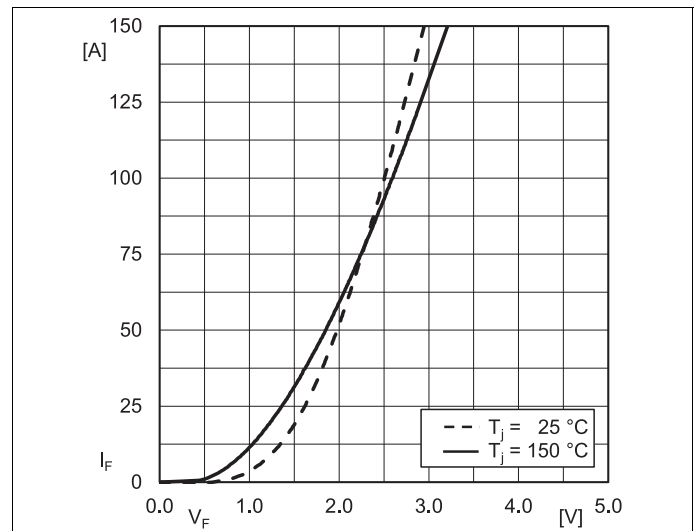

Fig. 10: Typ. Inv. diode forward charact., incl.  $R_{CC+EE'}$

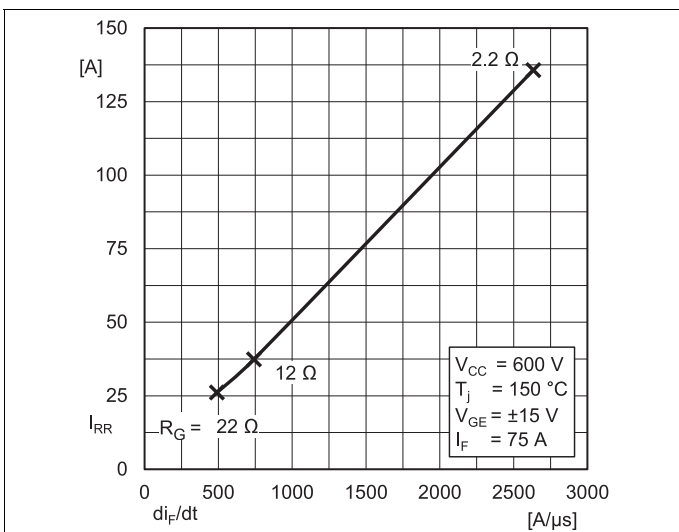

Fig. 11: Typ. Inv. diode peak reverse recovery current

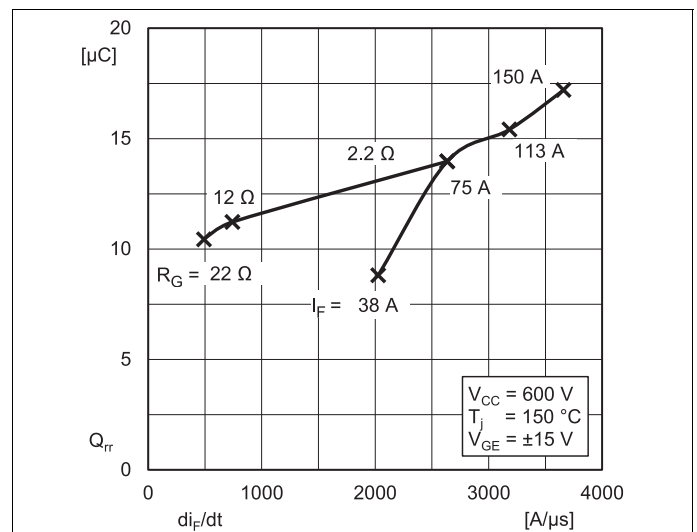
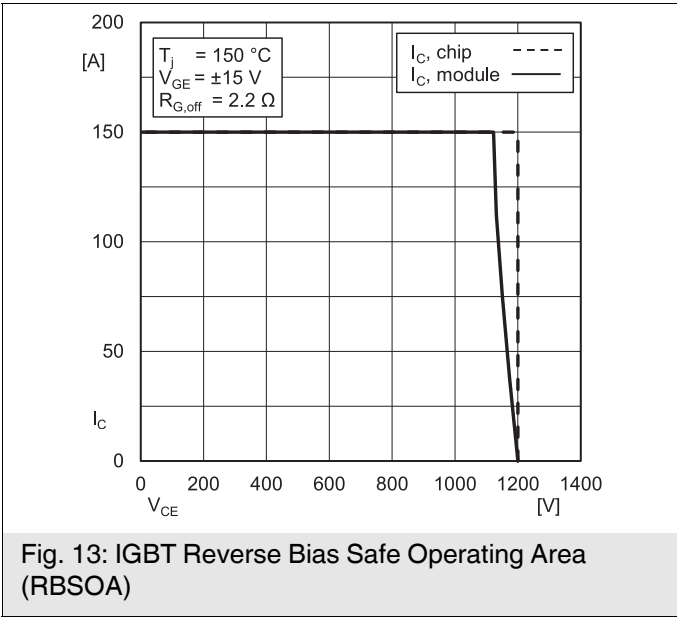
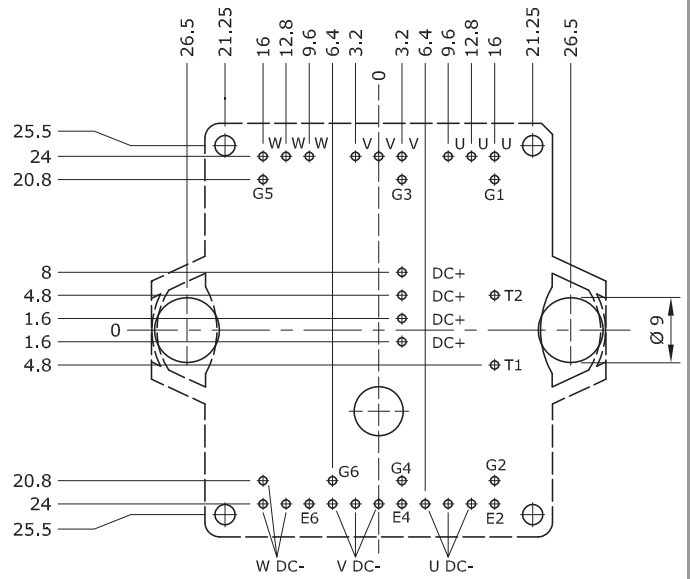
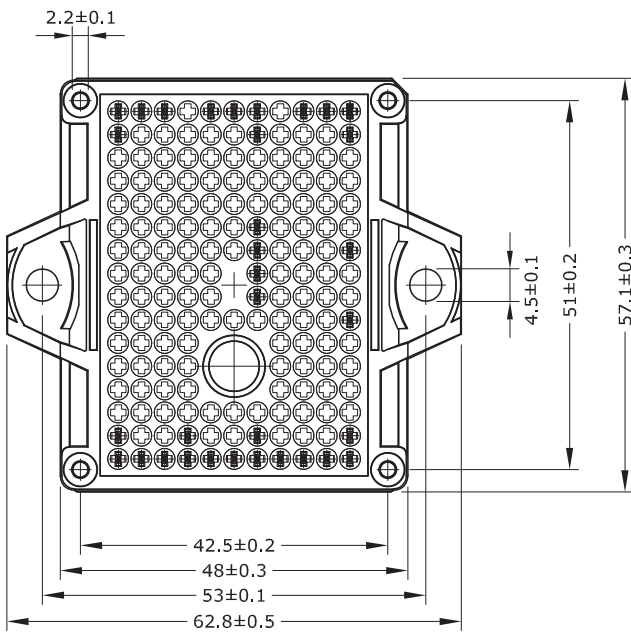
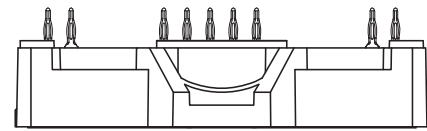
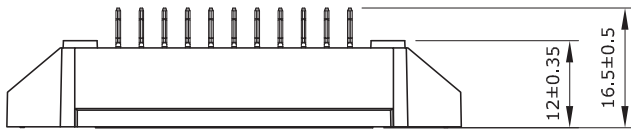

Fig. 12: Typ. Inv. diode reverse recovery charge



# SK75GD12T7ETE2



- Pin-Grid 3.2 mm
- Tolerance of PCB hole pattern  $\pm 0.1$
- Diameters of drill  $\varnothing 1.15\text{mm}$
- Copper thickness in hole 25 - 50  $\mu\text{m}$
- Hole specification for contacts:  
refer to SEMITOP E1/E2 Mounting Instruction

SEMITOP®E2

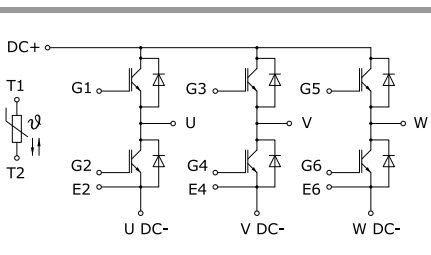

GD-ET

This is an electrostatic discharge sensitive device (ESDS) due to international standard IEC 61340.

## **\*IMPORTANT INFORMATION AND WARNINGS**

The specifications of SEMIKRON products may not be considered as guarantee or assurance of product characteristics ("Beschaffenheitsgarantie"). The specifications of SEMIKRON products describe only the usual characteristics of products to be expected in typical applications, which may still vary depending on the specific application. Therefore, products must be tested for the respective application in advance. Application adjustments may be necessary. The user of SEMIKRON products is responsible for the safety of their applications embedding SEMIKRON products and must take adequate safety measures to prevent the applications from causing a physical injury, fire or other problem if any of SEMIKRON products become faulty. The user is responsible to make sure that the application design is compliant with all applicable laws, regulations, norms and standards. Except as otherwise explicitly approved by SEMIKRON in a written document signed by authorized representatives of SEMIKRON, SEMIKRON products may not be used in any applications where a failure of the product or any consequences of the use thereof can reasonably be expected to result in personal injury. No representation or warranty is given and no liability is assumed with respect to the accuracy, completeness and/or use of any information herein, including without limitation, warranties of non-infringement of intellectual property rights of any third party. SEMIKRON does not assume any liability arising out of the applications or use of any product; neither does it convey any license under its patent rights, copyrights, trade secrets or other intellectual property rights, nor the rights of others. SEMIKRON makes no representation or warranty of non-infringement or alleged non-infringement of intellectual property rights of any third party which may arise from applications. Due to technical requirements our products may contain dangerous substances. For information on the types in question please contact the nearest SEMIKRON sales office. This document supersedes and replaces all information previously supplied and may be superseded by updates. SEMIKRON reserves the right to make changes.