



## SEMIPONT<sup>®</sup> 4

### Power Bridge Rectifiers

#### SKD 110

#### Features

- Robust plastic case with screw terminals
- Large, isolated base plate
- Blocking voltage up to 1800 V
- High surge currents
- Three phase bridge rectifier
- Easy chassis mounting
- UL recognized, file no. E 63 532

#### Typical Applications\*

- Three phase rectifiers for power supplies
- Input rectifiers for variable frequency drives
- Rectifiers for DC motor field supplies
- Battery charger rectifiers

1) Available in limited quantities

2) Mounted on a painted metal sheet of min. 250 x 250 x 1 mm;

$R_{th(c-a)} = 1,8 \text{ K/W}$

$V_{RSM}$ V	$V_{RRM}, V_{DRM}$ V	$I_D = 110 \text{ A}$ (full conduction) ( $T_c = 100 \text{ °C}$ )
800	800	SKD 110/08
1200	1200	SKD 110/12
1400	1400	SKD 110/14
1600	1600	SKD 110/16
1800	1800	SKD 110/18 <sup>1)</sup>

Symbol	Conditions	Values	Units
$I_D$	$T_c = 85 \text{ °C}$	151	A
	$T_a = 45 \text{ °C}$ ; chassis <sup>2)</sup>	28	A
	$T_a = 45 \text{ °C}$ ; P1/200	70	A
	$T_a = 35 \text{ °C}$ ; P1/120 F	110	A
	$T_a = 35 \text{ °C}$ ; P3/120 F	123	A
$I_{FSM}$	$T_{vj} = 25 \text{ °C}$ ; 10 ms	1200	A
	$T_{vj} = 150 \text{ °C}$ ; 10 ms	1000	A
$i^2t$	$T_{vj} = 25 \text{ °C}$ ; 8,3 ... 10 ms	7200	A <sup>2</sup> s
	$T_{vj} = 150 \text{ °C}$ ; 8,3 ... 10 ms	5000	A <sup>2</sup> s
$V_F$	$T_{vj} = 25 \text{ °C}$ ; $I_F = 300 \text{ A}$	max. 1,9	V
$V_{(TO)}$	$T_{vj} = 150 \text{ °C}$	max. 0,85	V
$r_T$	$T_{vj} = 150 \text{ °C}$	max. 4	mΩ
$I_{RD}$	$T_{vj} = 25 \text{ °C}$ ; $V_{DD} = V_{DRM}$ ; $V_{RD} = V_{RRM}$	max. 0,5	mA
	$T_{vj} = 150 \text{ °C}$ ; $V_{RD} = V_{RRM}$	5	mA
$R_{th(j-c)}$	per diode	0,9	K/W
	total	0,15	K/W
$R_{th(c-s)}$	total	0,03	K/W
$T_{vj}$		- 40 ... + 150	°C
$T_{stg}$		- 40 ... + 125	°C
$V_{isol}$	a. c. 50 Hz; r.m.s.; 1 s / 1 min.	3600 ( 3000 )	V
$M_s$	to heatsink	$5 \pm 15 \%$	Nm
$M_t$	to terminals	$5 \pm 15 \%$	Nm
$m$		270	g
Case		G 37	

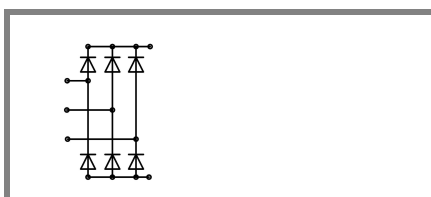

SKD

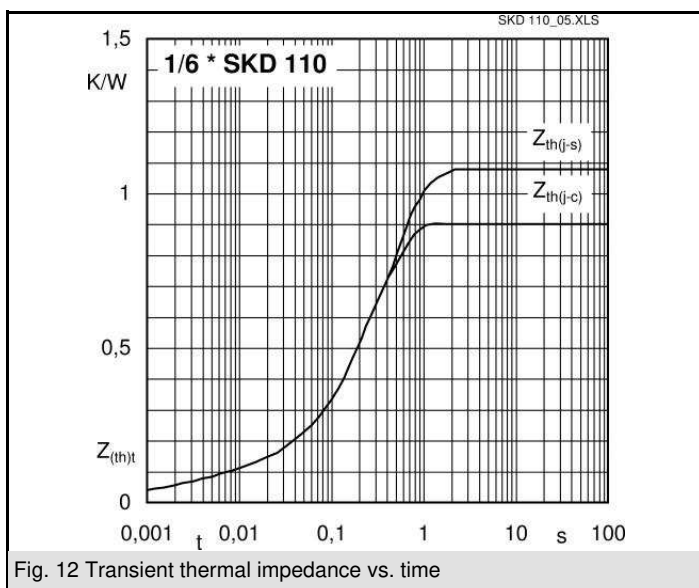
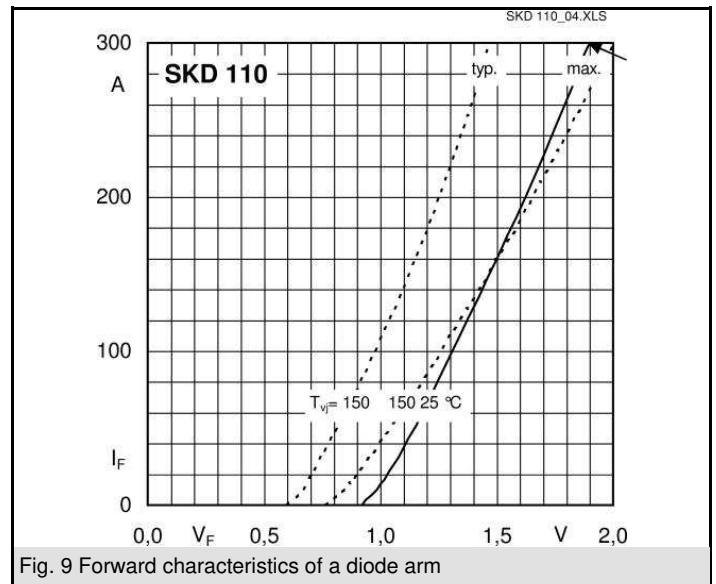
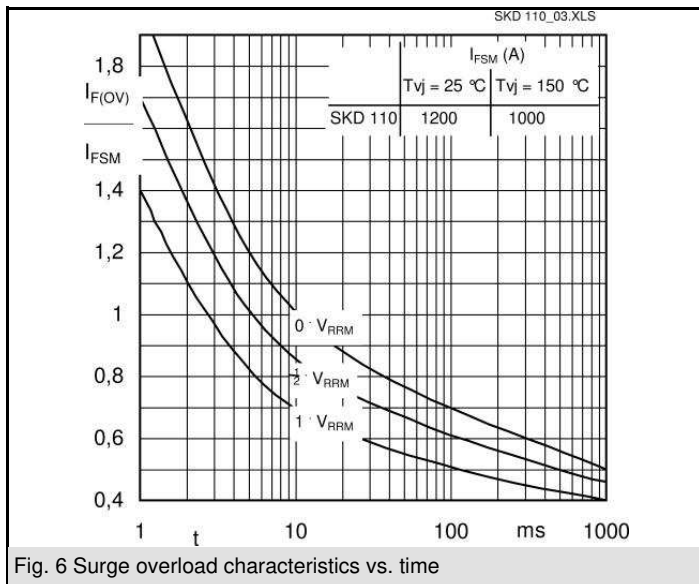
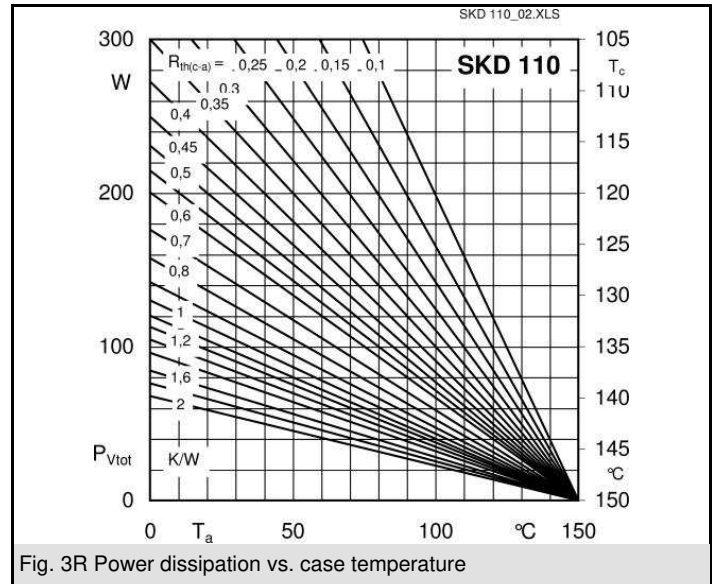
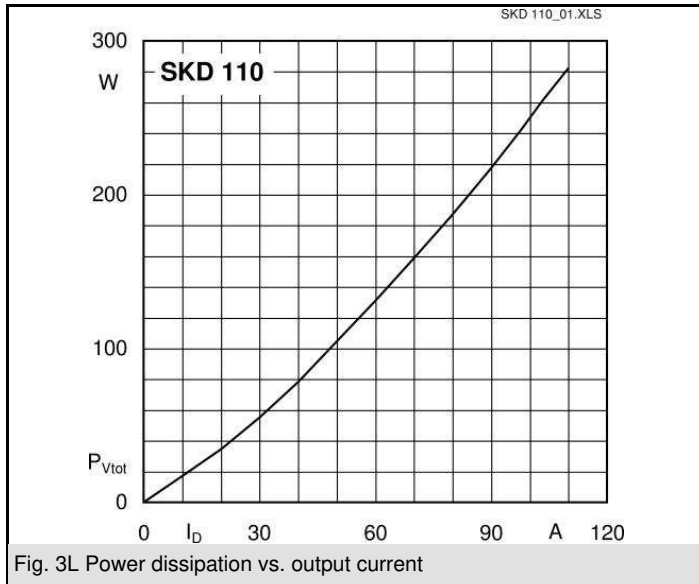

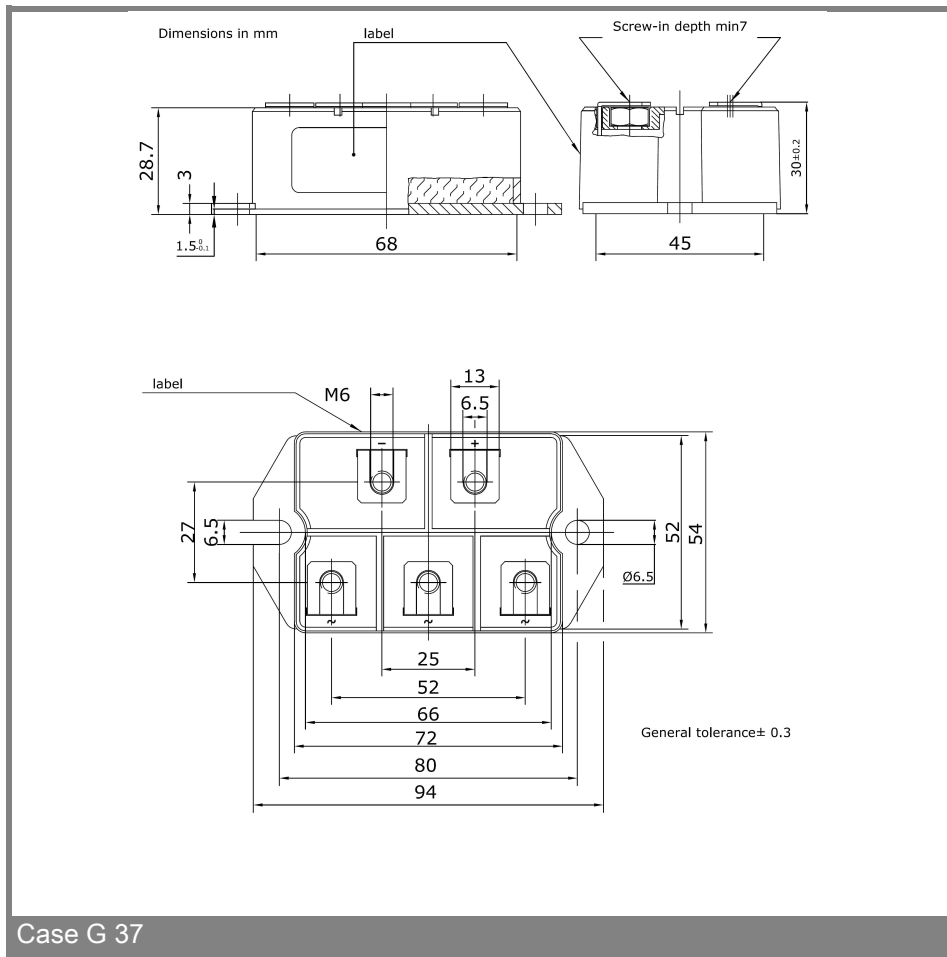

This is an electrostatic discharge sensitive device (ESDS) due to international standard IEC 61340.

### \*IMPORTANT INFORMATION AND WARNINGS

The specifications of SEMIKRON products may not be considered as guarantee or assurance of product characteristics ("Beschaffenheitsgarantie"). The specifications of SEMIKRON products describe only the usual characteristics of products to be expected in typical applications, which may still vary depending on the specific application. Therefore, products must be tested for the respective application in advance. Application adjustments may be necessary. The user of SEMIKRON products is responsible for the safety of their applications embedding SEMIKRON products and must take adequate safety measures to prevent the applications from causing a physical injury, fire or other problem if any of SEMIKRON products become faulty. The user is responsible to make sure that the application design is compliant with all applicable laws, regulations, norms and standards. Except as otherwise explicitly approved by SEMIKRON in a written document signed by authorized representatives of SEMIKRON, SEMIKRON products may not be used in any applications where a failure of the product or any consequences of the use thereof can reasonably be expected to result in personal injury. No representation or warranty is given and no liability is assumed with respect to the accuracy, completeness and/or use of any information herein, including without limitation, warranties of non-infringement of intellectual property rights of any third party. SEMIKRON does not assume any liability arising out of the applications or use of any product; neither does it convey any license under its patent rights, copyrights, trade secrets or other intellectual property rights, nor the rights of others. SEMIKRON makes no representation or warranty of non-infringement or alleged non-infringement of intellectual property rights of any third party which may arise from applications. Due to technical requirements our products may contain dangerous substances. For information on the types in question please contact the nearest SEMIKRON sales office. This document supersedes and replaces all information previously supplied and may be superseded by updates. SEMIKRON reserves the right to make changes.