

SKKT 57, SKKH 57, SKKT 57B



SEMIPACK[®] 1

Thyristor / Diode Modules

SKKT 57
SKKH 57
SKKT 57B

Features

- Heat transfer through aluminium oxide ceramic isolated metal baseplate
- Hard soldered joints for high reliability
- UL recognized, file no. E 63 532

Typical Applications*

- DC motor control (e. g. for machine tools)
- AC motor soft starters
- Temperature control (e. g. for ovens, chemical processes)
- Professional light dimming (studios, theaters)

1) See the assembly instructions

V_{RSM} V	V_{RRM}, V_{DRM} V	$I_{TRMS} = 95 \text{ A}$ (maximum value for continuous operation)		
		$I_{TAV} = 55 \text{ A}$ (sin. 180; $T_c = 80 \text{ }^\circ\text{C}$)		
900	800	SKKT 57/08E	SKKT 57B08E	SKKH 57/08E
1300	1200	SKKT 57/12E	SKKT 57B12E	SKKH 57/12E
1500	1400	SKKT 57/14E	SKKT 57B14E	SKKH 57/14E
1700	1600	SKKT 57/16E	SKKT 57B16E	SKKH 57/16E
1900	1800	SKKT 57/18E	SKKT 57B18E	SKKH 57/18E

Symbol	Conditions	Values	Units
I_{TAV}	sin. 180; $T_c = 85$ (100) $^\circ\text{C}$;	50 (35)	A
I_D	P3/180; $T_a = 45 \text{ }^\circ\text{C}$; B2 / B6	57 / 68	A
	P3/180F; $T_a = 35 \text{ }^\circ\text{C}$; B2 / B6	100 / 130	A
I_{RMS}	P3/180F; $T_a = 35 \text{ }^\circ\text{C}$; W1 / W3	130 / 3 x 100	A
I_{TSM}	$T_{vj} = 25 \text{ }^\circ\text{C}$; 10 ms	1500	A
	$T_{vj} = 125 \text{ }^\circ\text{C}$; 10 ms	1250	A
i^2t	$T_{vj} = 25 \text{ }^\circ\text{C}$; 8,3 ... 10 ms	11000	A ² s
	$T_{vj} = 125 \text{ }^\circ\text{C}$; 8,3 ... 10 ms	8000	A ² s
V_T	$T_{vj} = 25 \text{ }^\circ\text{C}$; $I_T = 200 \text{ A}$	max. 1,65	V
$V_{T(TO)}$	$T_{vj} = 125 \text{ }^\circ\text{C}$	max. 0,9	V
r_T	$T_{vj} = 125 \text{ }^\circ\text{C}$	max. 3,5	m Ω
I_{DD}, I_{RD}	$T_{vj} = 125 \text{ }^\circ\text{C}$; $V_{RD} = V_{RRM}$; $V_{DD} = V_{DRM}$	max. 15	mA
t_{gd}	$T_{vj} = 25 \text{ }^\circ\text{C}$; $I_G = 1 \text{ A}$; $di_G/dt = 1 \text{ A}/\mu\text{s}$	1	μs
t_{gr}	$V_D = 0,67 * V_{DRM}$	2	μs
$(di/dt)_{cr}$	$T_{vj} = 125 \text{ }^\circ\text{C}$	max. 150	A/ μs
$(dv/dt)_{cr}$	$T_{vj} = 125 \text{ }^\circ\text{C}$	max. 1000	V/ μs
t_q	$T_{vj} = 125 \text{ }^\circ\text{C}$,	80	μs
I_H	$T_{vj} = 25 \text{ }^\circ\text{C}$; typ. / max.	150 / 250	mA
I_L	$T_{vj} = 25 \text{ }^\circ\text{C}$; $R_G = 33 \text{ } \Omega$; typ. / max.	300 / 600	mA
V_{GT}	$T_{vj} = 25 \text{ }^\circ\text{C}$; d.c.	min. 3	V
I_{GT}	$T_{vj} = 25 \text{ }^\circ\text{C}$; d.c.	min. 150	mA
V_{GD}	$T_{vj} = 125 \text{ }^\circ\text{C}$; d.c.	max. 0,25	V
I_{GD}	$T_{vj} = 125 \text{ }^\circ\text{C}$; d.c.	max. 6	mA
$R_{th(j-c)}$	cont.; per thyristor / per module	0,57 / 0,29	K/W
$R_{th(j-c)}$	sin. 180; per thyristor / per module	0,6 / 0,3	K/W
$R_{th(j-c)}$	rec. 120; per thyristor / per module	0,64 / 0,32	K/W
$R_{th(c-s)}$	per thyristor / per module	0,2 / 0,1	K/W
T_{vj}		- 40 ... + 125	$^\circ\text{C}$
T_{stg}		- 40 ... + 125	$^\circ\text{C}$
V_{isol}	a. c. 50 Hz; r.m.s.; 1 s / 1 min.	3600 / 3000	V~
M_s	to heatsink	$5 \pm 15 \%$ ¹⁾	Nm
M_t	to terminals	$3 \pm 15 \%$	Nm
a		$5 * 9,81$	m/s ²
m	approx.	95	g
Case	SKKT	A 46	
	SKKT ...B	A 48	
	SKKH	A 47	



SKKT SKKH

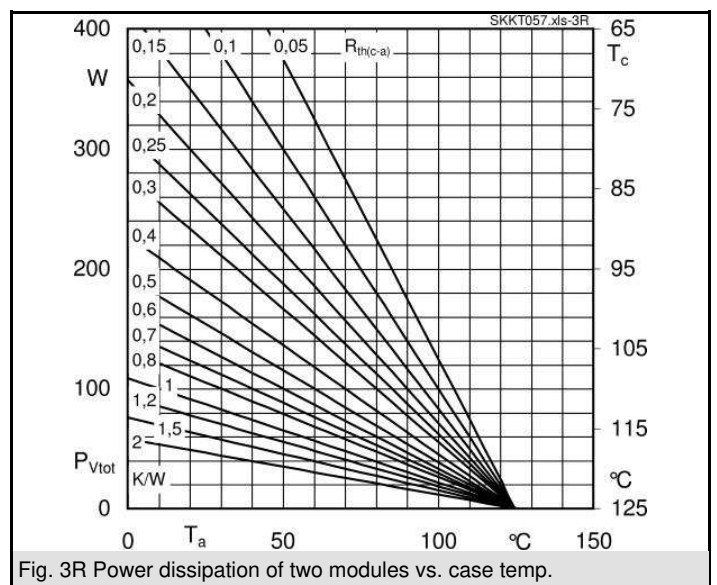
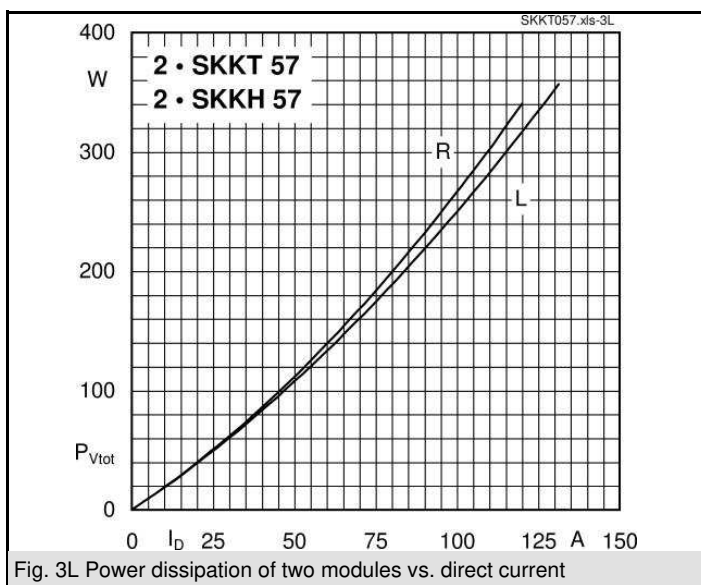
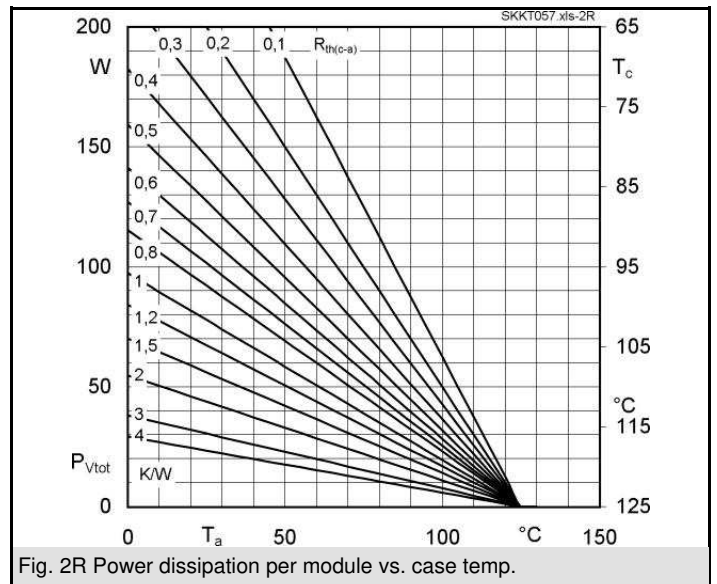
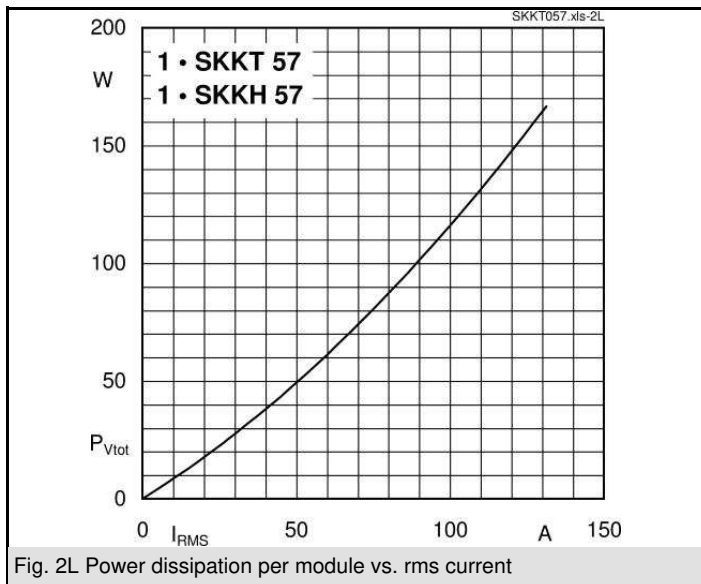
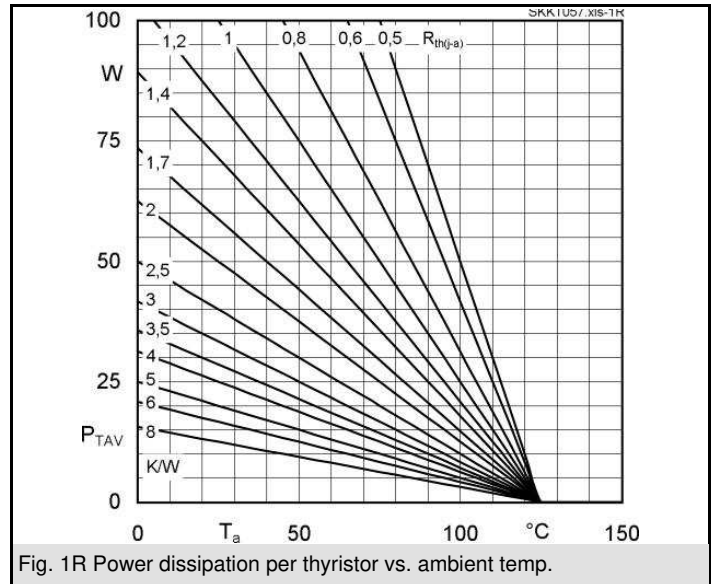
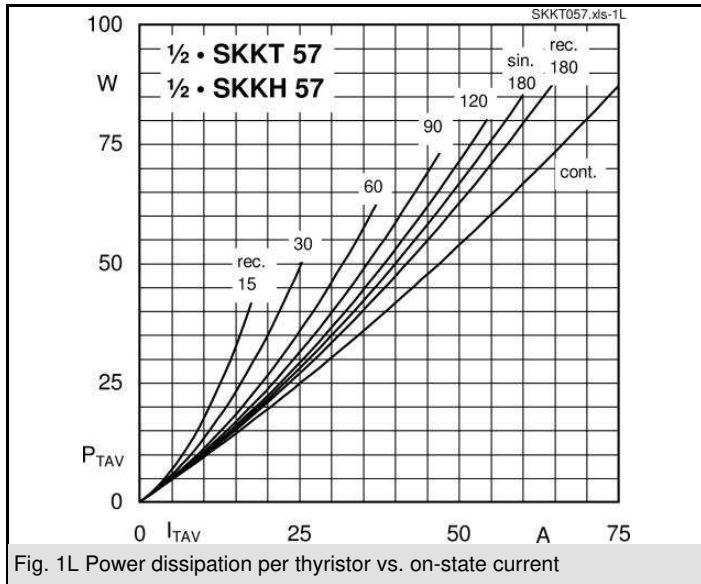

SKKT 57, SKKH 57, SKKT 57B

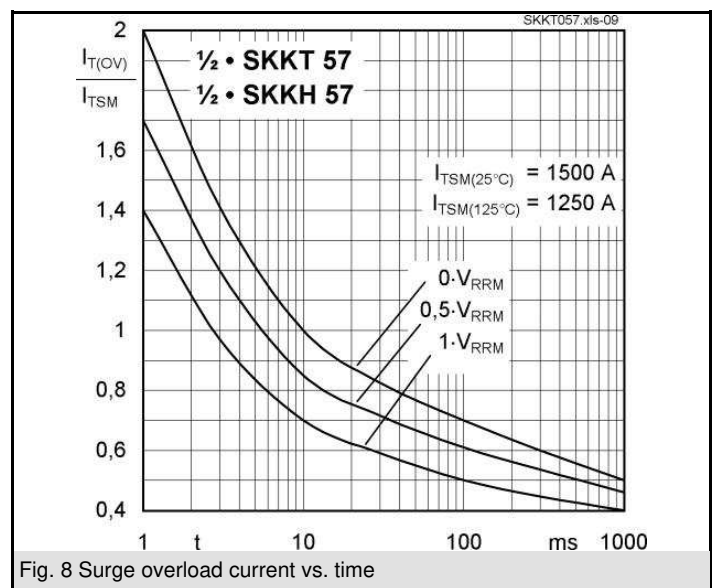
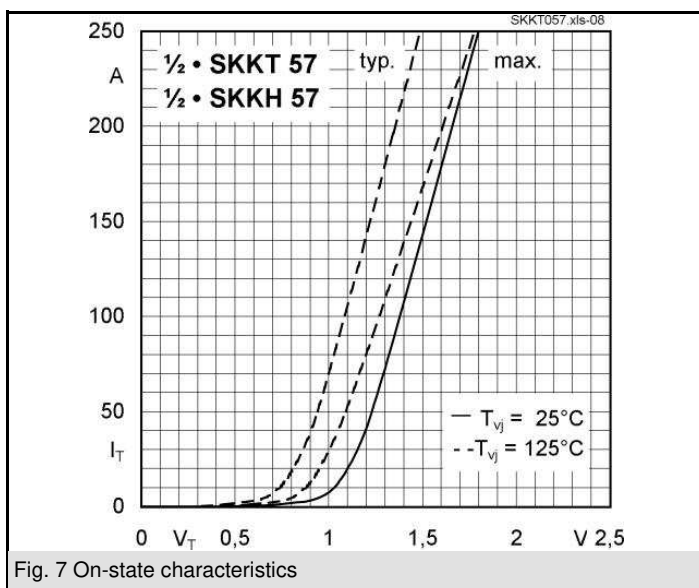
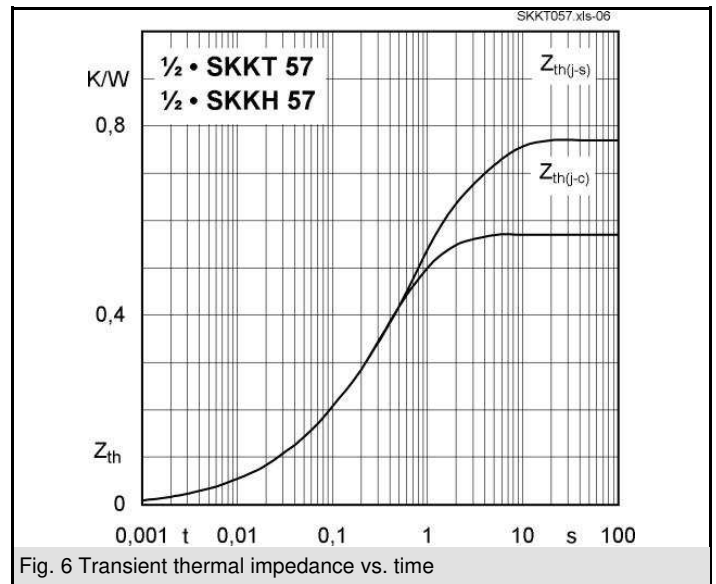
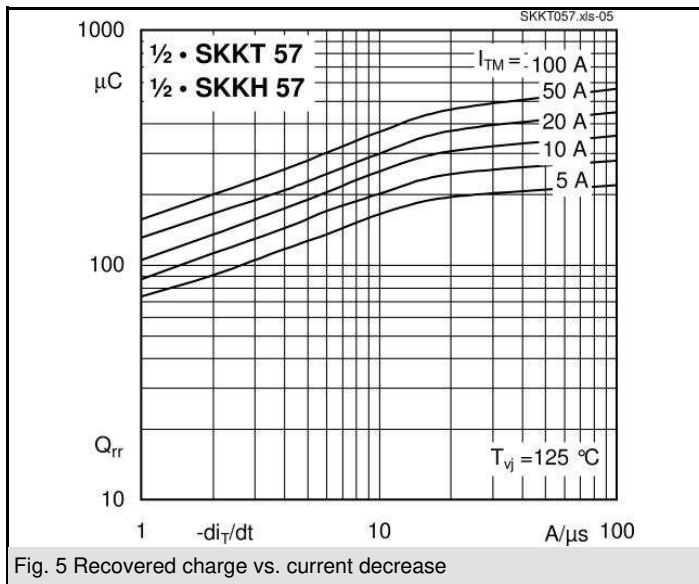
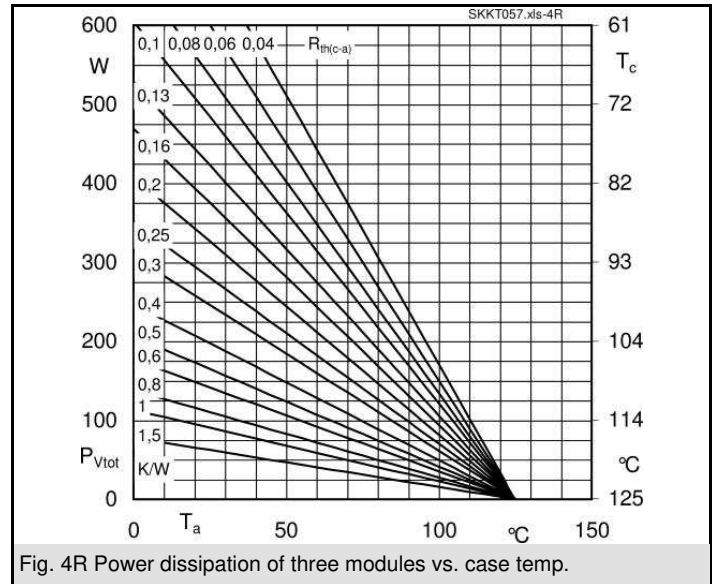
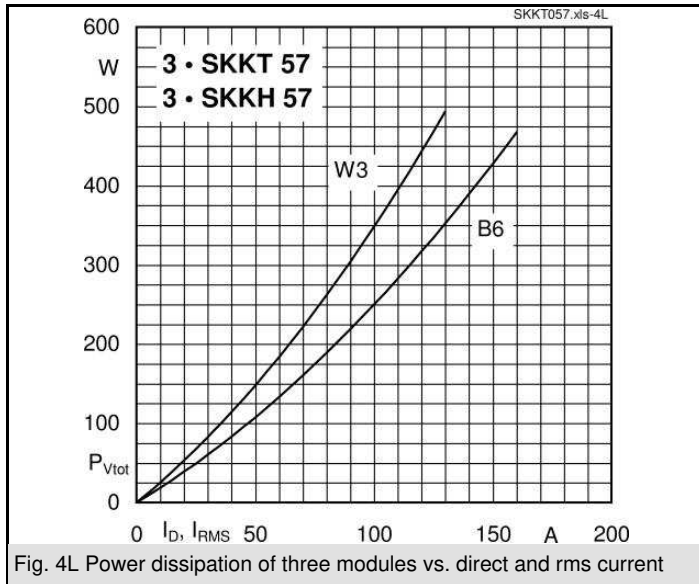

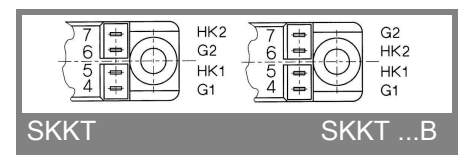
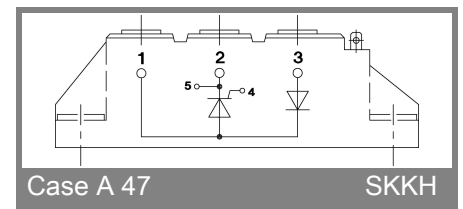
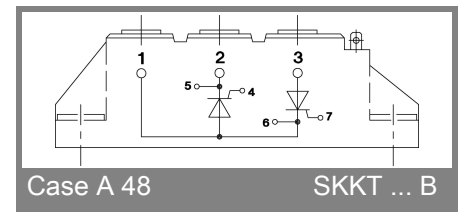
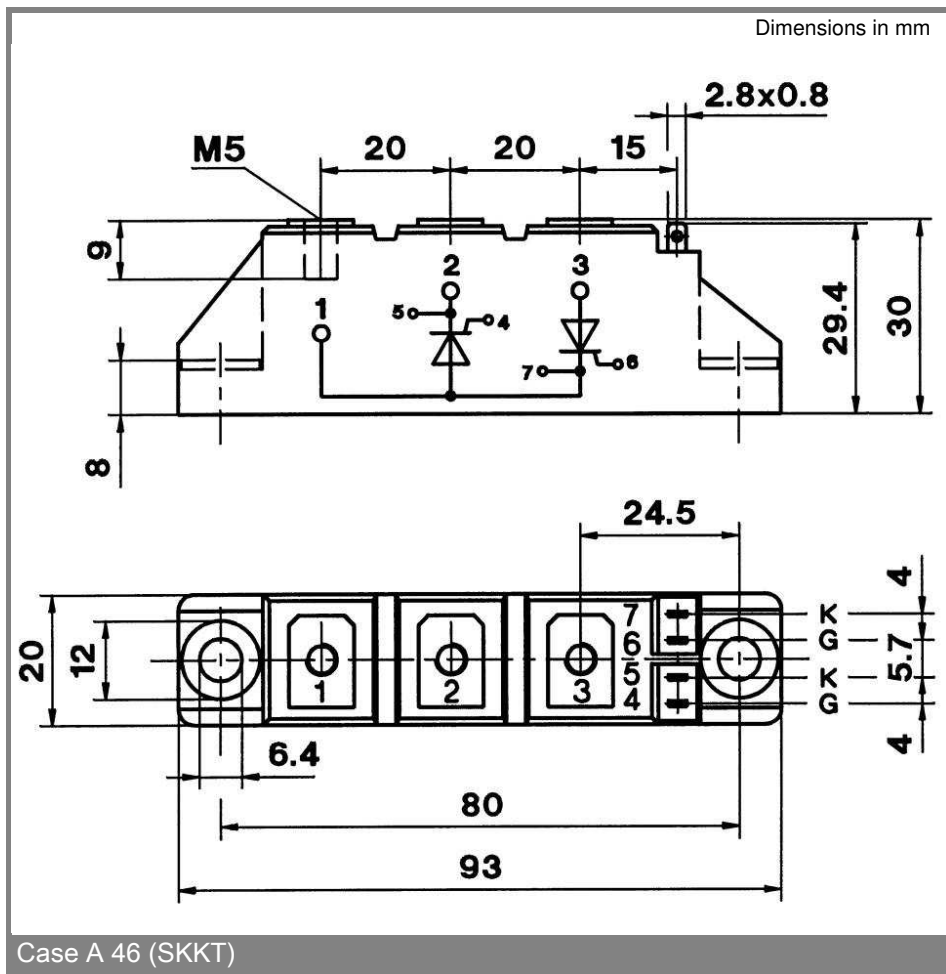
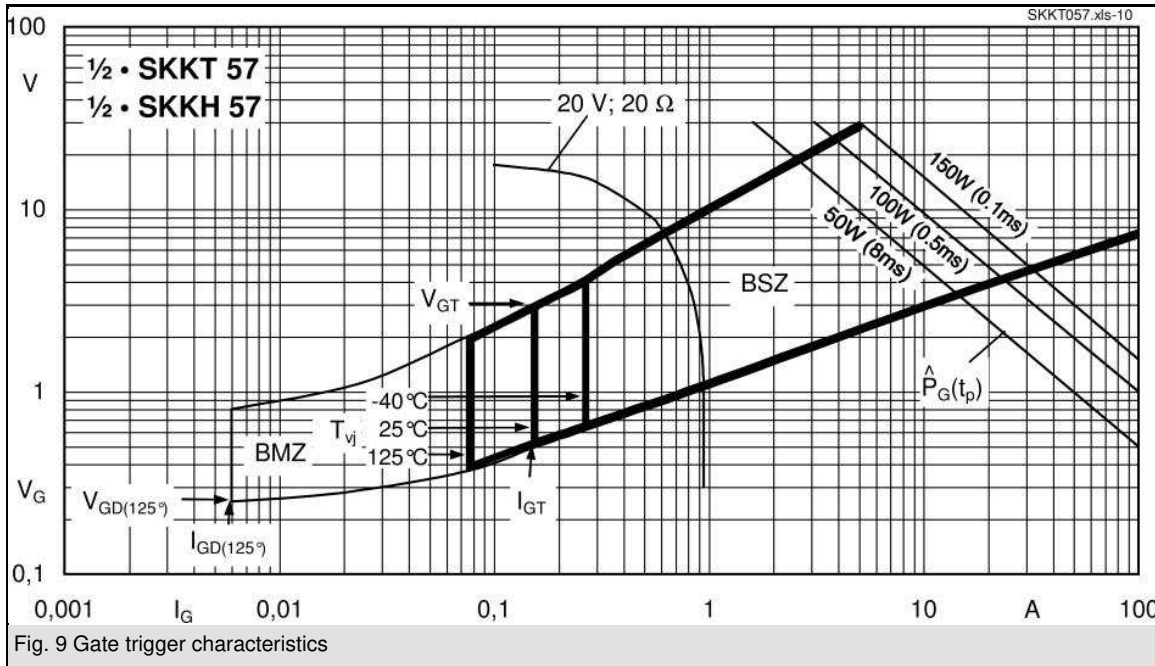

* The specifications of our components may not be considered as an assurance of component characteristics. Components have to be tested for the respective application. Adjustments may be necessary. The use of SEMIKRON products in life support appliances and systems is subject to prior specification and written approval by SEMIKRON. We therefore strongly recommend prior consultation of our staff.