

# SKiiP 11AC12T7V1



MiniSKiiP® 1

## Sixpack

### SKiiP 11AC12T7V1

#### Features\*

- 1200V Generation 7 IGBTs (T7)
- Robust and soft switching freewheeling diodes in CAL technology
- Highly reliable spring contacts for electrical connections
- UL recognized: File no. E63532

#### Remarks

- Max. case temperature limited to  $T_C = T_S = 125\text{ °C}$
- Product reliability results valid for  $T_j \leq 150\text{ °C}$ ;  $T_{j,op} > 150\text{ °C}$  during overload (Details see AN19-002)
- MiniSKiiP "Technical Explanations" and "Mounting Instructions" are part of the data sheet. Please refer to both documents for further information.
- For storage and case temperature with TIM see document "Technical Explanations Thermal Interface Materials"

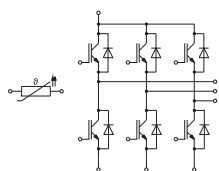

AC

#### Absolute Maximum Ratings

Symbol	Conditions	Values	Unit	
<b>Inverter - IGBT</b>				
$V_{CES}$	$T_j = 25\text{ °C}$	1200	V	
$I_C$	$\lambda_{paste}=0.8\text{ W/(mK)}$	$T_s = 70\text{ °C}$	20	A
	$T_j = 175\text{ °C}$	$T_s = 100\text{ °C}$	16	A
$I_C$	$\lambda_{paste}=2.5\text{ W/(mK)}$	$T_s = 70\text{ °C}$	22	A
	$T_j = 175\text{ °C}$	$T_s = 100\text{ °C}$	18	A
$I_{Chom}$		10	A	
$I_{CRM}$		20	A	
$V_{GES}$		-20 ... 20	V	
$t_{psc}$	$V_{CC} = 800\text{ V}$ $V_{GE} \leq 15\text{ V}$ $V_{CES} \leq 1200\text{ V}$	$T_j = 175\text{ °C}$	7	$\mu\text{s}$
$T_j$		-40 ... 175	$^{\circ}\text{C}$	
<b>Inverse - Diode</b>				
$V_{RRM}$	$T_j = 25\text{ °C}$	1200	V	
$I_F$	$\lambda_{paste}=0.8\text{ W/(mK)}$	$T_s = 70\text{ °C}$	13	A
	$T_j = 175\text{ °C}$	$T_s = 100\text{ °C}$	11	A
$I_F$	$\lambda_{paste}=2.5\text{ W/(mK)}$	$T_s = 70\text{ °C}$	14	A
	$T_j = 175\text{ °C}$	$T_s = 100\text{ °C}$	12	A
$I_{FRM}$		16	A	
$I_{FSM}$	$t_p = 10\text{ ms, sin } 180^{\circ}, T_j = 150\text{ °C}$	36	A	
$T_j$		-40 ... 175	$^{\circ}\text{C}$	
<b>Module</b>				
$I_{t(RMS)}$	$T_{terminal} = 80\text{ °C}, 20\text{ A per spring}$	40	A	
$T_{stg}$	module without TIM	-40 ... 125	$^{\circ}\text{C}$	
$V_{isol}$	AC sinus 50 Hz, $t = 1\text{ min}$	2500	V	

#### Characteristics

Symbol	Conditions	min.	typ.	max.	Unit
<b>Inverter - IGBT</b>					
$V_{CE(sat)}$	$I_C = 10\text{ A}$ $V_{GE} = 15\text{ V}$ chiplevel	$T_j = 25\text{ °C}$	1.60	1.75	V
		$T_j = 150\text{ °C}$	1.78	1.93	V
		$T_j = 175\text{ °C}$	1.82	1.97	V
$V_{CE0}$	chiplevel	$T_j = 25\text{ °C}$	1.00	1.05	V
		$T_j = 150\text{ °C}$	0.80	0.85	V
		$T_j = 175\text{ °C}$	0.75	0.80	V
$r_{CE}$	$V_{GE} = 15\text{ V}$ chiplevel	$T_j = 25\text{ °C}$	60	70	$\text{m}\Omega$
		$T_j = 150\text{ °C}$	98	108	$\text{m}\Omega$
		$T_j = 175\text{ °C}$	107	117	$\text{m}\Omega$
$V_{GE(th)}$	$V_{GE} = V_{CE}, I_C = 0.22\text{ mA}$	5.15	5.8	6.45	V
$I_{CES}$	$V_{GE} = 0\text{ V}, V_{CE} = 1200\text{ V}, T_j = 25\text{ °C}$			1	mA
$C_{ies}$	$V_{CE} = 25\text{ V}$		1.90		nF
$C_{oes}$	$V_{GE} = 0\text{ V}$		0.02		nF
$C_{res}$			0.01		nF
$Q_G$	$V_{GE} = -8\text{ V} \dots +15\text{ V}$		140		nC
$R_{Gint}$	$T_j = 25\text{ °C}$		0		$\Omega$

# SKiiP 11AC12T7V1



MiniSKiiP® 1

## Sixpack

### SKiiP 11AC12T7V1

#### Features\*

- 1200V Generation 7 IGBTs (T7)
- Robust and soft switching freewheeling diodes in CAL technology
- Highly reliable spring contacts for electrical connections
- UL recognized: File no. E63532

#### Remarks

- Max. case temperature limited to  $T_C = T_S = 125\text{ °C}$
- Product reliability results valid for  $T_j \leq 150\text{ °C}$ ;  $T_{j,op} > 150\text{ °C}$  during overload (Details see AN19-002)
- MiniSKiiP "Technical Explanations" and "Mounting Instructions" are part of the data sheet. Please refer to both documents for further information.
- For storage and case temperature with TIM see document "Technical Explanations Thermal Interface Materials"

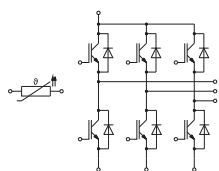

AC

Characteristics						
Symbol	Conditions	min.	typ.	max.	Unit	
<b>Inverter - IGBT</b>						
$t_{d(on)}$		$T_j = 25\text{ °C}$	44		ns	
		$T_j = 150\text{ °C}$	46		ns	
		$T_j = 175\text{ °C}$	47		ns	
$t_r$	$V_{CC} = 600\text{ V}$ $I_C = 10\text{ A}$	$T_j = 25\text{ °C}$	39		ns	
		$T_j = 150\text{ °C}$	44		ns	
		$T_j = 175\text{ °C}$	47		ns	
$E_{on}$	$R_{G, on} = 32\text{ }\Omega$ $R_{G, off} = 32\text{ }\Omega$ $V_{GE} = +15/-15\text{ V}$	$T_j = 25\text{ °C}$	0.88		mJ	
		$T_j = 150\text{ °C}$	1.2		mJ	
		$T_j = 175\text{ °C}$	1.3		mJ	
$t_{d(off)}$		$T_j = 25\text{ °C}$	198		ns	
		@ $T_j = 150\text{ °C}$ : $dI/dt_{on} = 190\text{ A}/\mu\text{s}$	$T_j = 150\text{ °C}$	288		ns
		$T_j = 175\text{ °C}$	313		ns	
$t_f$	$dI/dt_{off} = 130\text{ A}/\mu\text{s}$ $dV/dt = 3580\text{ V}/\mu\text{s}$	$T_j = 25\text{ °C}$	42		ns	
		$T_j = 150\text{ °C}$	63		ns	
		$T_j = 175\text{ °C}$	85		ns	
$E_{off}$		$T_j = 25\text{ °C}$	0.65		mJ	
		$T_j = 150\text{ °C}$	1.1		mJ	
		$T_j = 175\text{ °C}$	1.2		mJ	
$R_{th(j-s)}$	per IGBT, $\lambda_{paste} = 0.8\text{ W}/(\text{mK})$		1.7		K/W	
$R_{th(j-s)}$	per IGBT, $\lambda_{paste} = 2.5\text{ W}/(\text{mK})$		1.46		K/W	

Characteristics					
Symbol	Conditions	min.	typ.	max.	Unit
<b>Inverse - Diode</b>					
$V_F = V_{EC}$	$I_F = 10\text{ A}$ $V_{GE} = 0\text{ V}$ chiplevel	$T_j = 25\text{ °C}$	2.59	2.94	V
		$T_j = 150\text{ °C}$	2.71	3.08	V
		$T_j = 175\text{ °C}$	2.53	2.89	V
$V_{F0}$	chiplevel	$T_j = 25\text{ °C}$	1.30	1.50	V
		$T_j = 150\text{ °C}$	0.90	1.10	V
		$T_j = 175\text{ °C}$	0.82	0.98	V
$r_F$	chiplevel	$T_j = 25\text{ °C}$	129	144	m $\Omega$
		$T_j = 150\text{ °C}$	181	198	m $\Omega$
		$T_j = 175\text{ °C}$	171	191	m $\Omega$
$I_{RRM}$		$T_j = 25\text{ °C}$	6		A
		$T_j = 150\text{ °C}$	7		A
		$T_j = 175\text{ °C}$	8		A
$Q_{rr}$	$I_F = 10\text{ A}$ $V_{GE} = +15/-15\text{ V}$ $V_{CC} = 600\text{ V}$	$T_j = 25\text{ °C}$	0.7		$\mu\text{C}$
		$T_j = 150\text{ °C}$	1.4		$\mu\text{C}$
		@ $T_j = 150\text{ °C}$ : $dI/dt_{off} = 210\text{ A}/\mu\text{s}$	$T_j = 175\text{ °C}$	1.6	
$E_{rr}$		$T_j = 25\text{ °C}$	0.19		mJ
		$T_j = 150\text{ °C}$	0.53		mJ
		$T_j = 175\text{ °C}$	0.69		mJ
$R_{th(j-s)}$	per Diode, $\lambda_{paste} = 0.8\text{ W}/(\text{mK})$		2.33		K/W
$R_{th(j-s)}$	per Diode, $\lambda_{paste} = 2.5\text{ W}/(\text{mK})$		2		K/W
<b>Module</b>					
$L_{CE}$			-		nH
$M_s$	to heat sink	2		2.5	Nm
w			30		g

# SKiiP 11AC12T7V1

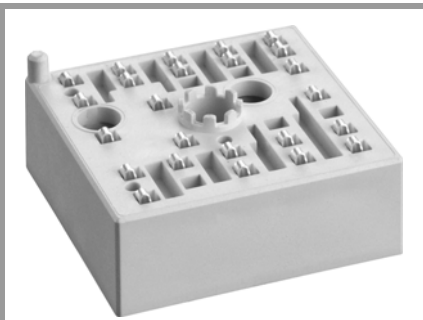

MiniSKiiP® 1

## Sixpack

### SKiiP 11AC12T7V1

#### Features\*

- 1200V Generation 7 IGBTs (T7)
- Robust and soft switching freewheeling diodes in CAL technology
- Highly reliable spring contacts for electrical connections
- UL recognized: File no. E63532

#### Remarks

- Max. case temperature limited to  $T_C=T_S=125\text{ °C}$
- Product reliability results valid for  $T_j \leq 150\text{ °C}$ ;  $T_{j,op} > 150\text{ °C}$  during overload (Details see AN19-002)
- MiniSKiiP "Technical Explanations" and "Mounting Instructions" are part of the data sheet. Please refer to both documents for further information.
- For storage and case temperature with TIM see document "Technical Explanations Thermal Interface Materials"

Characteristics					
Symbol	Conditions	min.	typ.	max.	Unit
<b>Temperature Sensor</b>					
$R_{100}$	$T_r=100\text{ °C}$ ( $R_{25}=1000\Omega$ )		$1670 \pm 3\%$		$\Omega$
$R_{(T)}$	$R_{(T)}=1000\Omega[1+A(T-25\text{ °C})+B(T-25\text{ °C})^2]$ $A = 7.635 \cdot 10^{-3}\text{ °C}^{-1}$ , $B = 1.731 \cdot 10^{-5}\text{ °C}^{-2}$				

Creepage distance (spring to spring) between temperature sensor and phase W = 2.9mm (CTI 600)

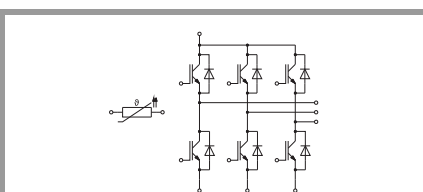

AC

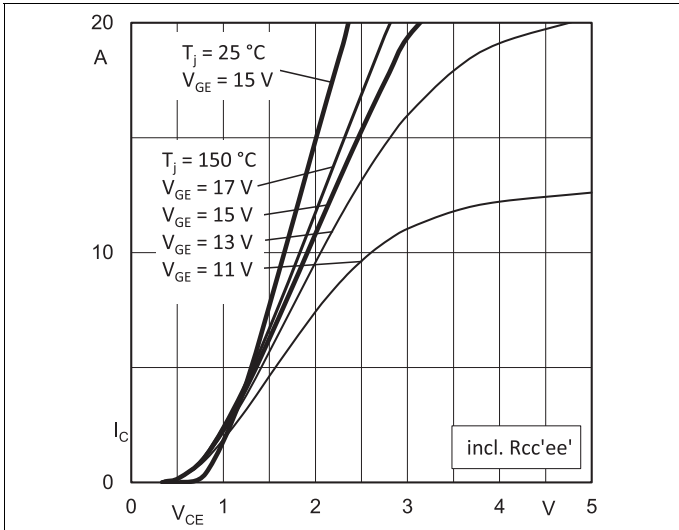

Fig. 1: Typ. output characteristic

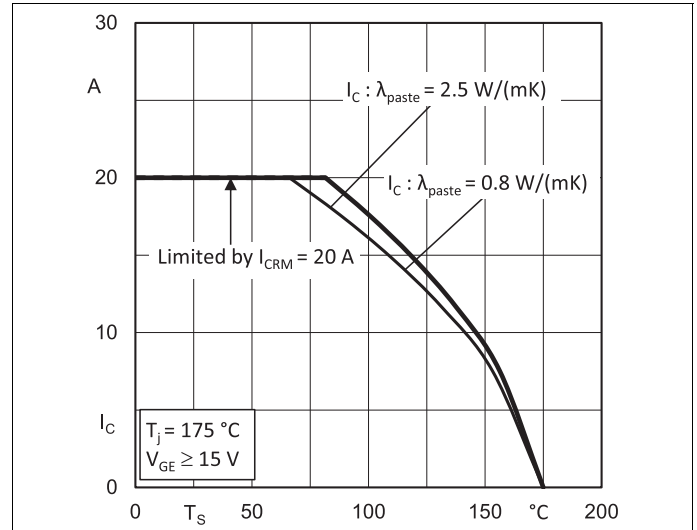

Fig. 2: Rated current vs. temperature  $I_C = f(T_s)$

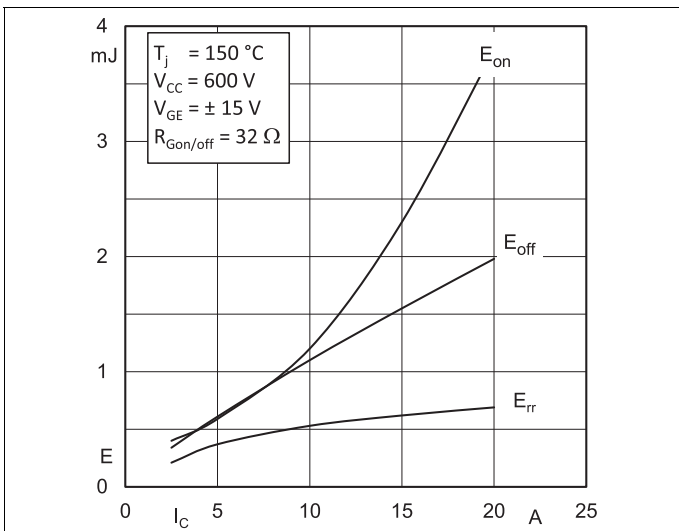

Fig. 3: Typ. turn-on /-off energy =  $f(I_C)$

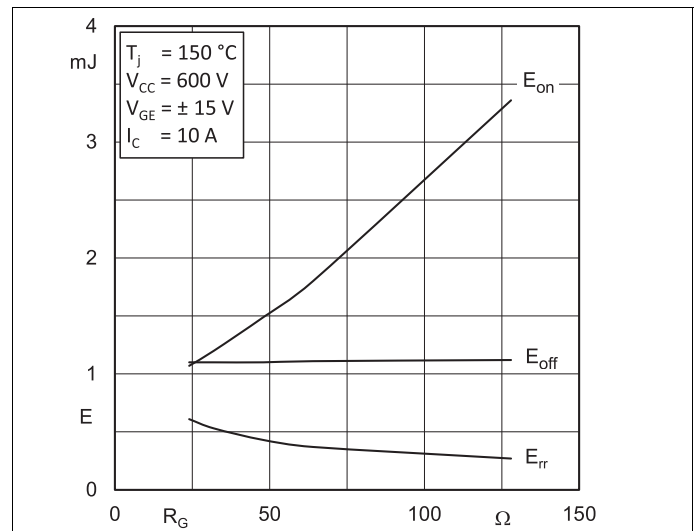

Fig. 4: Typ. turn-on /-off energy =  $f(R_G)$

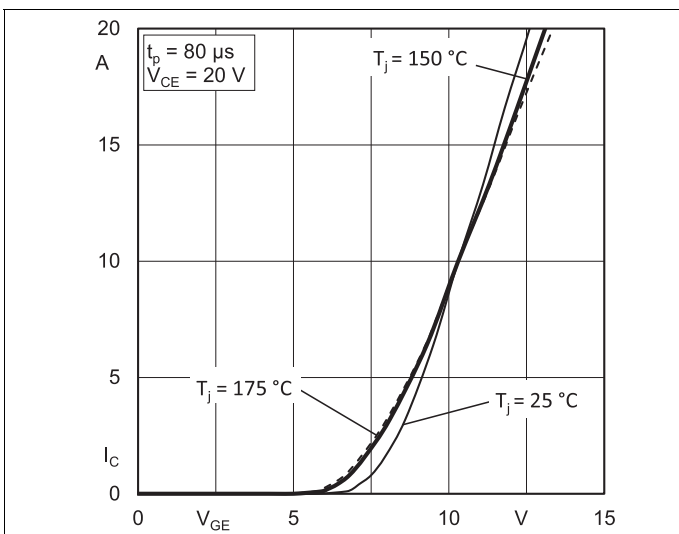

Fig. 5: Typ. transfer characteristic

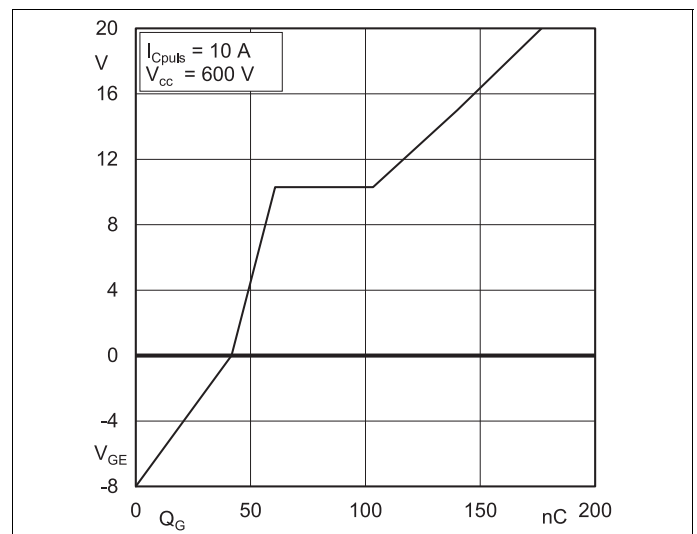

Fig. 6: Typ. gate charge characteristic

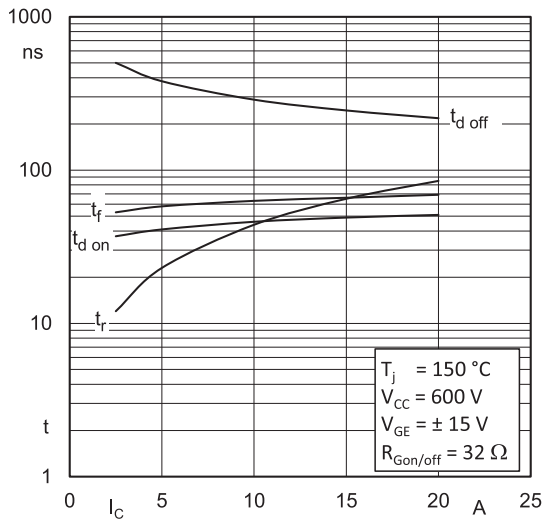

Fig. 7: Typ. switching times vs.  $I_C$

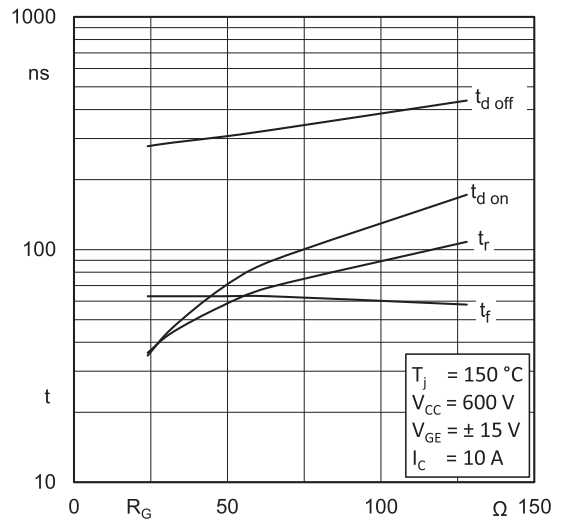

Fig. 8: Typ. switching times vs. gate resistor  $R_G$

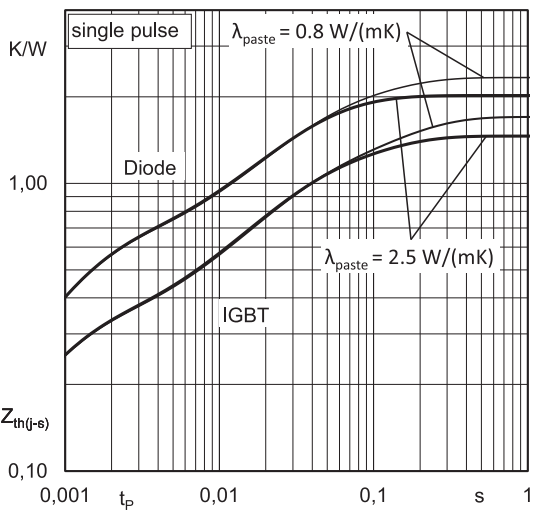

Fig. 9: Typ. transient thermal impedance

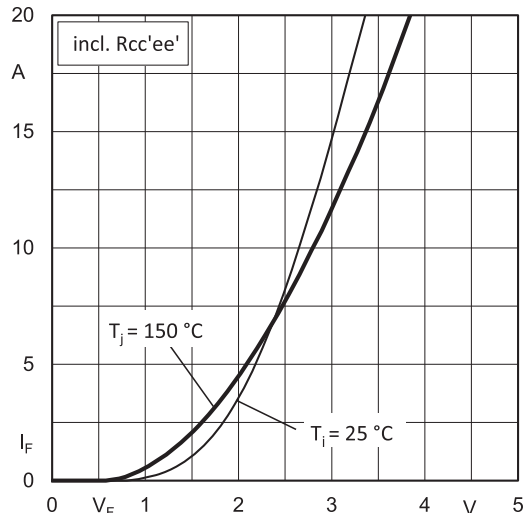

Fig. 10: Typ. CAL diode forward characteristic

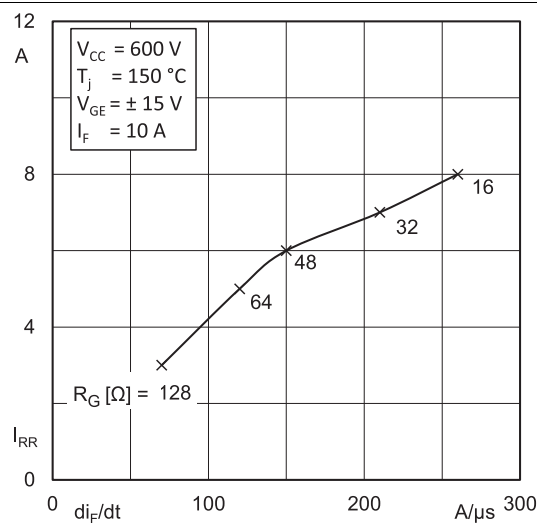

Fig. 11: Typ. CAL diode peak reverse recovery current

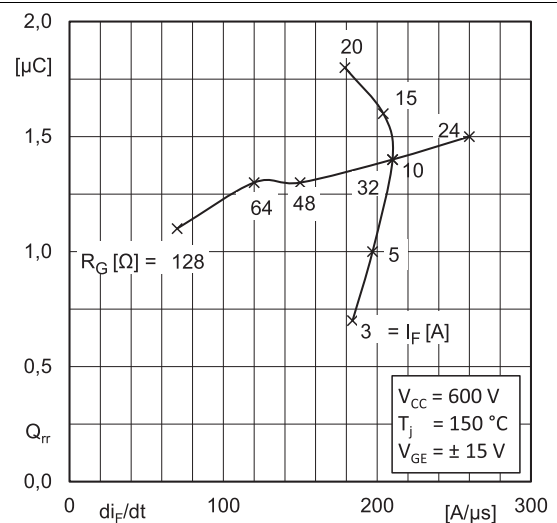
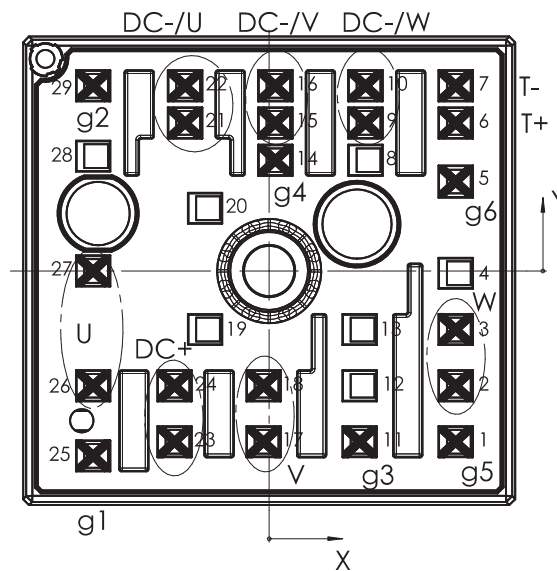

Fig. 12: Typ. CAL diode recovery charge

Pin out							
Pin	X	Y	Function	Pin	X	Y	Function
1	15,93	-14,6	g5	16	0,53	15,8	DC-/V
2	15,93	-9,8	W	17	-0,48	-14,6	V
3	15,93	-5	W	18	-0,48	-9,8	V
4				19			
5	15,93	7,63	g6	20			
6	15,93	12,63	T+	21	-7,18	12,63	DC-/U
7	15,93	15,8	T-	22	-7,18	15,8	DC-/U
8				23	-8,08	-14,6	DC+
9	8,23	12,63	DC-/W	24	-8,08	-9,8	DC+
10	8,23	15,8	DC-/W	25	-15,03	-15,8	g1
11	7,73	-14,6	g3	26	-15,03	-9,8	U
12	7,73	-9,8		27	-15,03	0	U
13				28			
14	0,53	9,45	g4	29	-15,03	15,8	g2
15	0,53	12,63	DC-/V				

all values in mm



Pinout and Dimensions

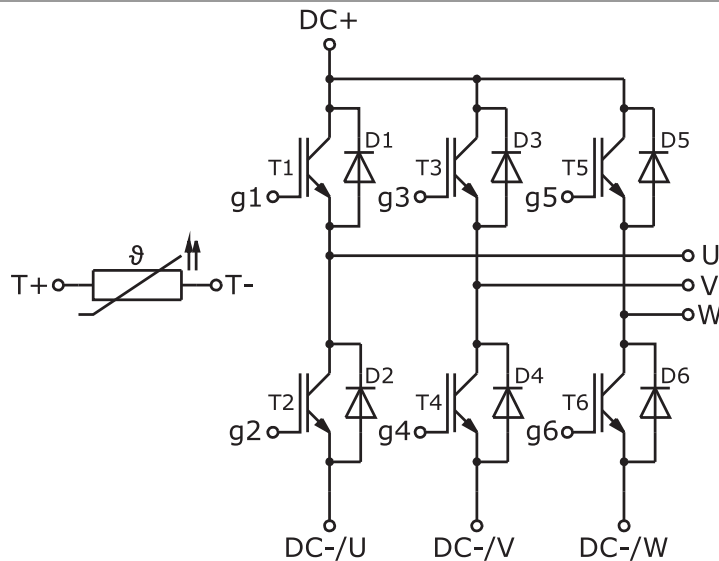

Pinout

This is an electrostatic discharge sensitive device (ESDS) due to international standard IEC 61340.

## **\*IMPORTANT INFORMATION AND WARNINGS**

The specifications of SEMIKRON products may not be considered as guarantee or assurance of product characteristics ("Beschaffenheitsgarantie"). The specifications of SEMIKRON products describe only the usual characteristics of products to be expected in typical applications, which may still vary depending on the specific application. Therefore, products must be tested for the respective application in advance. Application adjustments may be necessary. The user of SEMIKRON products is responsible for the safety of their applications embedding SEMIKRON products and must take adequate safety measures to prevent the applications from causing a physical injury, fire or other problem if any of SEMIKRON products become faulty. The user is responsible to make sure that the application design is compliant with all applicable laws, regulations, norms and standards. Except as otherwise explicitly approved by SEMIKRON in a written document signed by authorized representatives of SEMIKRON, SEMIKRON products may not be used in any applications where a failure of the product or any consequences of the use thereof can reasonably be expected to result in personal injury. No representation or warranty is given and no liability is assumed with respect to the accuracy, completeness and/or use of any information herein, including without limitation, warranties of non-infringement of intellectual property rights of any third party. SEMIKRON does not assume any liability arising out of the applications or use of any product; neither does it convey any license under its patent rights, copyrights, trade secrets or other intellectual property rights, nor the rights of others. SEMIKRON makes no representation or warranty of non-infringement or alleged non-infringement of intellectual property rights of any third party which may arise from applications. Due to technical requirements our products may contain dangerous substances. For information on the types in question please contact the nearest SEMIKRON sales office. This document supersedes and replaces all information previously supplied and may be superseded by updates. SEMIKRON reserves the right to make changes.