

SKiiP 12AC12T7V1



MiniSKiiP® 1

Sixpack

SKiiP 12AC12T7V1

Features*

- 1200V Generation 7 IGBTs (T7)
- Robust and soft switching freewheeling diodes in CAL technology
- Highly reliable spring contacts for electrical connections
- UL recognized: File no. E63532

Remarks

- Max. case temperature limited to $T_C = T_S = 125\text{ °C}$
- Product reliability results valid for $T_j \leq 150\text{ °C}$; $T_{j,op} > 150\text{ °C}$ during overload (Details see AN19-002)
- MiniSKiiP "Technical Explanations" and "Mounting Instructions" are part of the data sheet. Please refer to both documents for further information.
- For storage and case temperature with TIM see document "Technical Explanations Thermal Interface Materials"

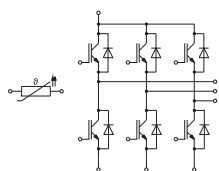

AC

Absolute Maximum Ratings				
Symbol	Conditions		Values	Unit
Inverter - IGBT				
V_{CES}	$T_j = 25\text{ °C}$		1200	V
I_C	$\lambda_{paste} = 0.8\text{ W/(mK)}$	$T_s = 70\text{ °C}$	26	A
		$T_j = 175\text{ °C}$	22	A
I_C	$\lambda_{paste} = 2.5\text{ W/(mK)}$	$T_s = 70\text{ °C}$	29	A
		$T_j = 175\text{ °C}$	24	A
I_{Chom}			15	A
I_{CRM}			30	A
V_{GES}			-20 ... 20	V
t_{psc}	$V_{CC} = 800\text{ V}$	$T_j = 175\text{ °C}$	7	μs
	$V_{GE} \leq 15\text{ V}$			
	$V_{CES} \leq 1200\text{ V}$			
T_j			-40 ... 175	$^{\circ}\text{C}$
Inverse - Diode				
V_{RRM}	$T_j = 25\text{ °C}$		1200	V
I_F	$\lambda_{paste} = 0.8\text{ W/(mK)}$	$T_s = 70\text{ °C}$	19	A
		$T_j = 175\text{ °C}$	16	A
I_F	$\lambda_{paste} = 2.5\text{ W/(mK)}$	$T_s = 70\text{ °C}$	21	A
		$T_j = 175\text{ °C}$	17	A
I_{FRM}			30	A
I_{FSM}	$t_p = 10\text{ ms, sin } 180^{\circ}, T_j = 150\text{ °C}$		65	A
T_j			-40 ... 175	$^{\circ}\text{C}$
Module				
$I_{t(RMS)}$	$T_{terminal} = 80\text{ °C}, 20\text{ A per spring}$		40	A
T_{stg}	module without TIM		-40 ... 125	$^{\circ}\text{C}$
V_{isol}	AC sinus 50 Hz, $t = 1\text{ min}$		2500	V

Characteristics						
Symbol	Conditions		min.	typ.	max.	Unit
Inverter - IGBT						
$V_{CE(sat)}$	$I_C = 15\text{ A}$	$T_j = 25\text{ °C}$	1.60	1.75		V
		$T_j = 150\text{ °C}$	1.78	1.93		V
		chiplevel	1.82	1.97		V
V_{CE0}	chiplevel	$T_j = 25\text{ °C}$	1.00	1.05		V
		$T_j = 150\text{ °C}$	0.80	0.85		V
		$T_j = 175\text{ °C}$	0.75	0.80		V
r_{CE}	$V_{GE} = 15\text{ V}$	$T_j = 25\text{ °C}$	40	47		$\text{m}\Omega$
		$T_j = 150\text{ °C}$	65	72		$\text{m}\Omega$
		chiplevel	71	78		$\text{m}\Omega$
$V_{GE(th)}$	$V_{GE} = V_{CE}, I_C = 0.33\text{ mA}$		5.15	5.8	6.45	V
I_{CES}	$V_{GE} = 0\text{ V}, V_{CE} = 1200\text{ V}, T_j = 25\text{ °C}$				1	mA
C_{ies}				2.80		nF
C_{oes}	$V_{CE} = 25\text{ V}$	$f = 1\text{ MHz}$		0.04		nF
C_{res}	$V_{GE} = 0\text{ V}$	$f = 1\text{ MHz}$		0.01		nF
Q_G	$V_{GE} = -8\text{ V} \dots +15\text{ V}$			210		nC
R_{Gint}	$T_j = 25\text{ °C}$			0		Ω

SKiiP 12AC12T7V1



MiniSKiiP® 1

Sixpack

SKiiP 12AC12T7V1

Features*

- 1200V Generation 7 IGBTs (T7)
- Robust and soft switching freewheeling diodes in CAL technology
- Highly reliable spring contacts for electrical connections
- UL recognized: File no. E63532

Remarks

- Max. case temperature limited to $T_C = T_S = 125\text{ °C}$
- Product reliability results valid for $T_j \leq 150\text{ °C}$; $T_{j,op} > 150\text{ °C}$ during overload (Details see AN19-002)
- MiniSKiiP "Technical Explanations" and "Mounting Instructions" are part of the data sheet. Please refer to both documents for further information.
- For storage and case temperature with TIM see document "Technical Explanations Thermal Interface Materials"

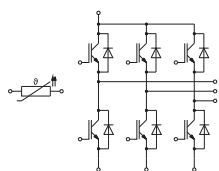

AC

Characteristics						
Symbol	Conditions	min.	typ.	max.	Unit	
Inverter - IGBT						
$t_{d(on)}$		$T_j = 25\text{ °C}$	43		ns	
		$T_j = 150\text{ °C}$	44		ns	
		$T_j = 175\text{ °C}$	46		ns	
t_r	$V_{CC} = 600\text{ V}$ $I_C = 15\text{ A}$	$T_j = 25\text{ °C}$	38		ns	
		$T_j = 150\text{ °C}$	44		ns	
		$T_j = 175\text{ °C}$	47		ns	
E_{on}	$R_{G, on} = 21.3\ \Omega$ $R_{G, off} = 21.3\ \Omega$ $V_{GE} = +15/-15\text{ V}$	$T_j = 25\text{ °C}$	1.3		mJ	
		$T_j = 150\text{ °C}$	1.9		mJ	
		$T_j = 175\text{ °C}$	2		mJ	
$t_{d(off)}$		$T_j = 25\text{ °C}$	205		ns	
		@ $T_j = 150\text{ °C}$: $dI/dt_{on} = 320\text{ A}/\mu\text{s}$	$T_j = 150\text{ °C}$	295		ns
		$T_j = 175\text{ °C}$	320		ns	
t_f	$dI/dt_{off} = 180\text{ A}/\mu\text{s}$ $dV/dt = 3590\text{ V}/\mu\text{s}$	$T_j = 25\text{ °C}$	44		ns	
		$T_j = 150\text{ °C}$	66		ns	
		$T_j = 175\text{ °C}$	85		ns	
E_{off}		$T_j = 25\text{ °C}$	0.98		mJ	
		$T_j = 150\text{ °C}$	1.7		mJ	
		$T_j = 175\text{ °C}$	1.8		mJ	
$R_{th(j-s)}$	per IGBT, $\lambda_{paste} = 0.8\text{ W}/(\text{mK})$		1.4		K/W	
$R_{th(j-s)}$	per IGBT, $\lambda_{paste} = 2.5\text{ W}/(\text{mK})$		1.2		K/W	

Characteristics					
Symbol	Conditions	min.	typ.	max.	Unit
Inverse - Diode					
$V_F = V_{EC}$	$I_F = 15\text{ A}$ $V_{GE} = 0\text{ V}$ chiplevel	$T_j = 25\text{ °C}$	2.38	2.71	V
		$T_j = 150\text{ °C}$	2.44	2.77	V
		$T_j = 175\text{ °C}$	2.26	2.58	V
V_{F0}	chiplevel	$T_j = 25\text{ °C}$	1.30	1.50	V
		$T_j = 150\text{ °C}$	0.90	1.10	V
		$T_j = 175\text{ °C}$	0.82	0.98	V
r_F	chiplevel	$T_j = 25\text{ °C}$	72	81	m Ω
		$T_j = 150\text{ °C}$	103	111	m Ω
		$T_j = 175\text{ °C}$	96	107	m Ω
I_{RRM}		$T_j = 25\text{ °C}$	9		A
		$T_j = 150\text{ °C}$	11		A
		$T_j = 175\text{ °C}$	13		A
Q_{rr}	$I_F = 15\text{ A}$ $V_{GE} = +15/-15\text{ V}$ $V_{CC} = 600\text{ V}$	$T_j = 25\text{ °C}$	0.9		μC
		$T_j = 150\text{ °C}$	2.1		μC
		@ $T_j = 150\text{ °C}$: $dI/dt_{off} = 350\text{ A}/\mu\text{s}$	$T_j = 175\text{ °C}$	2.4	
E_{rr}		$T_j = 25\text{ °C}$	0.27		mJ
		$T_j = 150\text{ °C}$	0.81		mJ
		$T_j = 175\text{ °C}$	1.1		mJ
$R_{th(j-s)}$	per Diode, $\lambda_{paste} = 0.8\text{ W}/(\text{mK})$		1.78		K/W
$R_{th(j-s)}$	per Diode, $\lambda_{paste} = 2.5\text{ W}/(\text{mK})$		1.53		K/W
Module					
L_{CE}			-		nH
M_s	to heat sink	2		2.5	Nm
w			30		g

SKiiP 12AC12T7V1

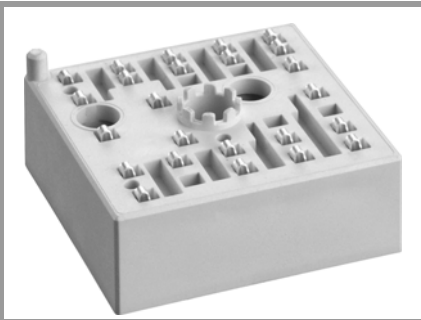

MiniSKiiP® 1

Sixpack

SKiiP 12AC12T7V1

Features*

- 1200V Generation 7 IGBTs (T7)
- Robust and soft switching freewheeling diodes in CAL technology
- Highly reliable spring contacts for electrical connections
- UL recognized: File no. E63532

Remarks

- Max. case temperature limited to $T_C=T_S=125\text{ °C}$
- Product reliability results valid for $T_j \leq 150\text{ °C}$; $T_{j,op} > 150\text{ °C}$ during overload (Details see AN19-002)
- MiniSKiiP "Technical Explanations" and "Mounting Instructions" are part of the data sheet. Please refer to both documents for further information.
- For storage and case temperature with TIM see document "Technical Explanations Thermal Interface Materials"

Characteristics					
Symbol	Conditions	min.	typ.	max.	Unit
Temperature Sensor					
R_{100}	$T_r=100\text{ °C}$ ($R_{25}=1000\Omega$)		$1670 \pm 3\%$		Ω
$R_{(T)}$	$R_{(T)}=1000\Omega[1+A(T-25\text{ °C})+B(T-25\text{ °C})^2]$ $A = 7.635 \cdot 10^{-3}\text{ °C}^{-1}$, $B = 1.731 \cdot 10^{-5}\text{ °C}^{-2}$				

Creepage distance (spring to spring) between temperature sensor and phase W = 2.9mm (CTI 600)

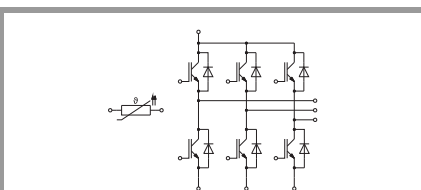

AC

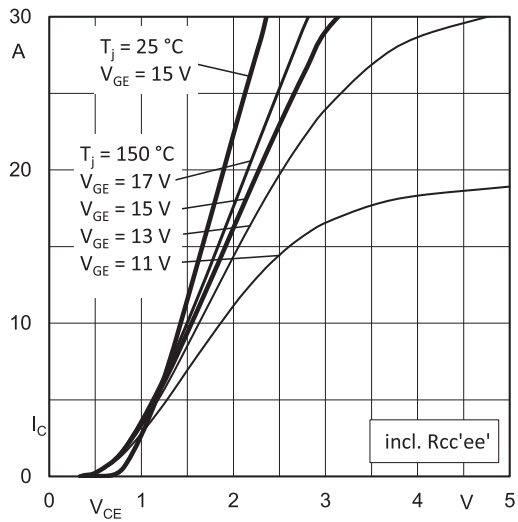

Fig. 1: Typ. output characteristic

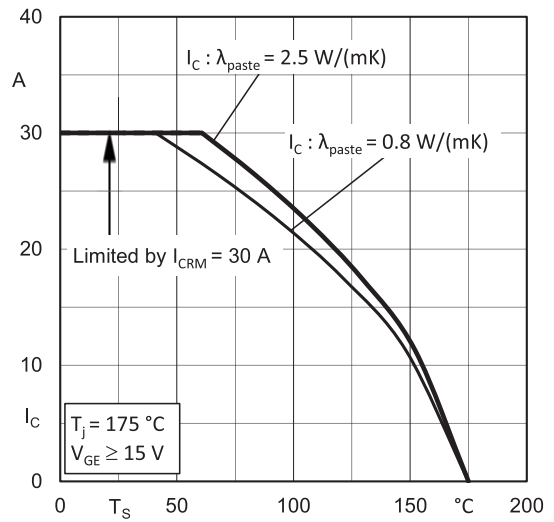

Fig. 2: Rated current vs. temperature $I_C = f(T_s)$

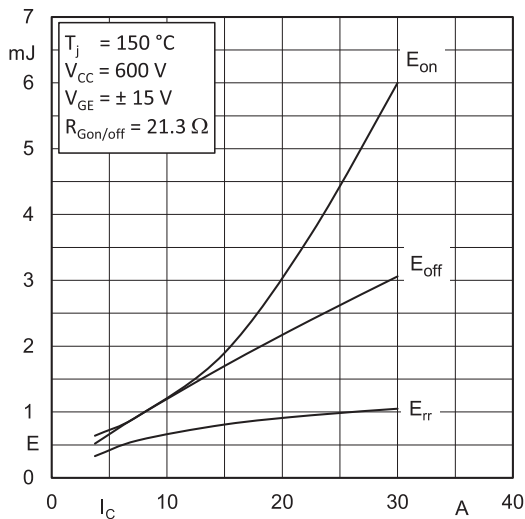

Fig. 3: Typ. turn-on /-off energy = $f(I_C)$

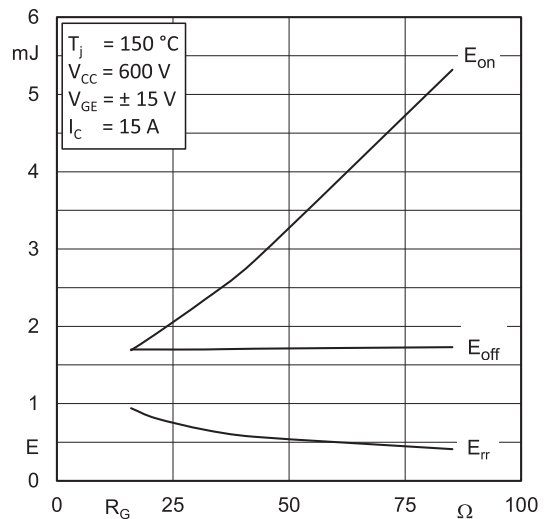

Fig. 4: Typ. turn-on /-off energy = $f(R_G)$

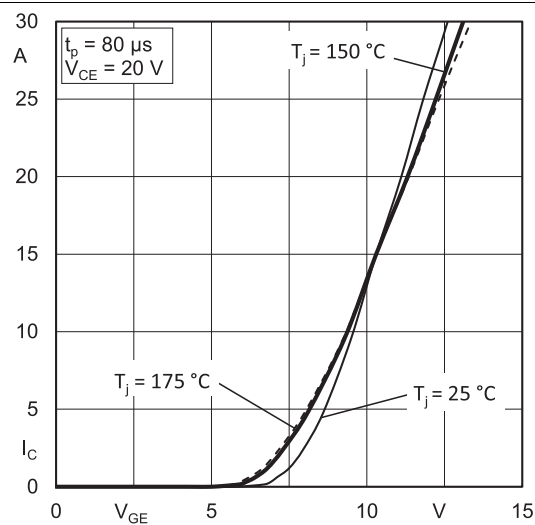

Fig. 5: Typ. transfer characteristic

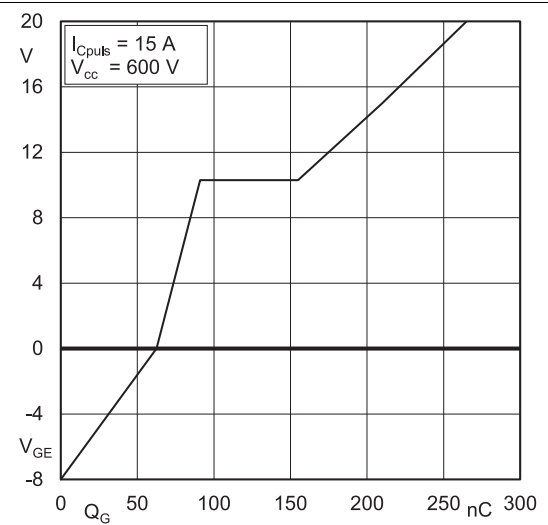

Fig. 6: Typ. gate charge characteristic

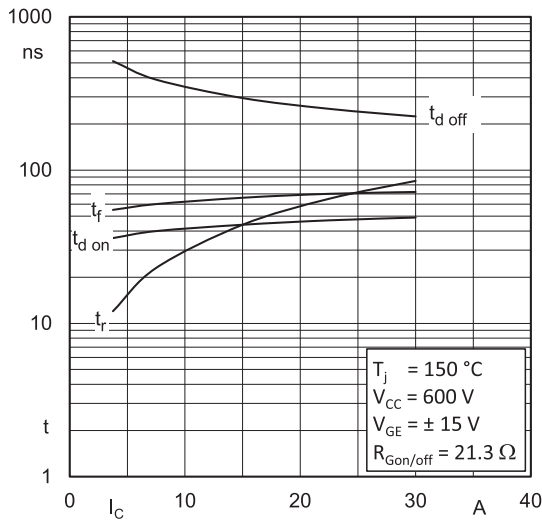

Fig. 7: Typ. switching times vs. I_C

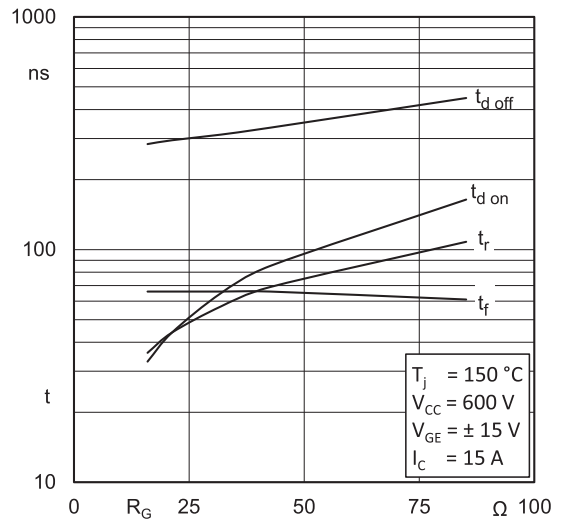

Fig. 8: Typ. switching times vs. gate resistor R_G

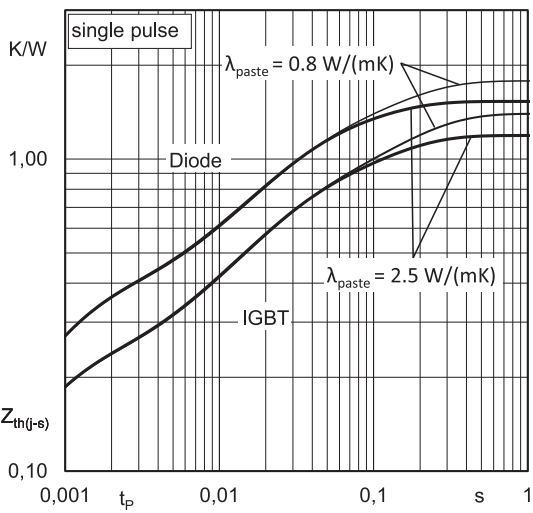

Fig. 9: Typ. transient thermal impedance

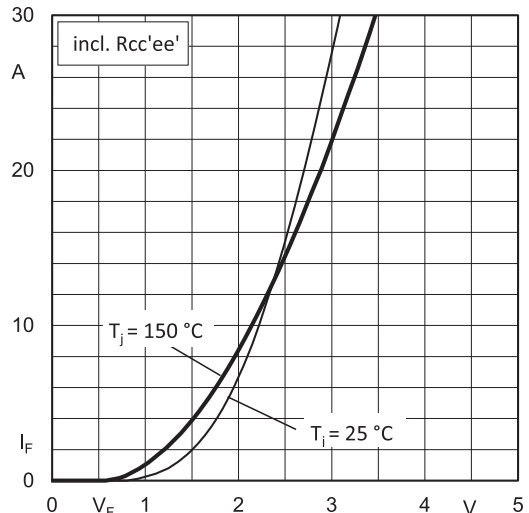

Fig. 10: Typ. CAL diode forward characteristic

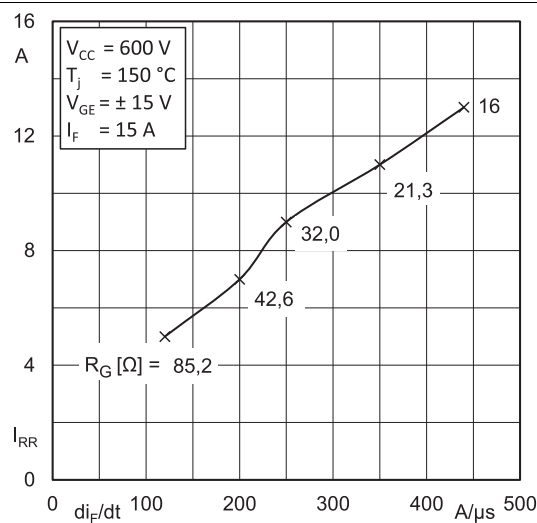

Fig. 11: Typ. CAL diode peak reverse recovery current

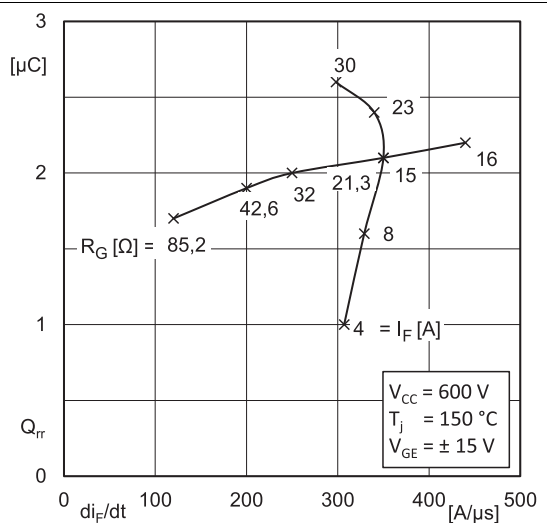
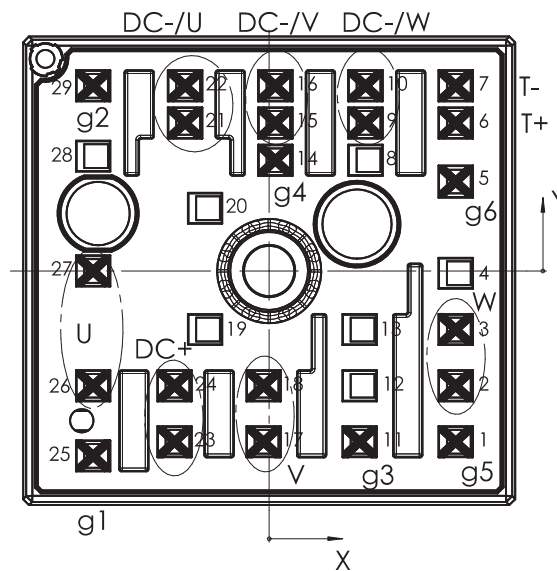

Fig. 12: Typ. CAL diode recovery charge

Pin out							
Pin	X	Y	Function	Pin	X	Y	Function
1	15,93	-14,6	g5	16	0,53	15,8	DC-/V
2	15,93	-9,8	W	17	-0,48	-14,6	V
3	15,93	-5	W	18	-0,48	-9,8	V
4				19			
5	15,93	7,63	g6	20			
6	15,93	12,63	T+	21	-7,18	12,63	DC-/U
7	15,93	15,8	T-	22	-7,18	15,8	DC-/U
8				23	-8,08	-14,6	DC+
9	8,23	12,63	DC-/W	24	-8,08	-9,8	DC+
10	8,23	15,8	DC-/W	25	-15,03	-15,8	g1
11	7,73	-14,6	g3	26	-15,03	-9,8	U
12	7,73	-9,8		27	-15,03	0	U
13				28			
14	0,53	9,45	g4	29	-15,03	15,8	g2
15	0,53	12,63	DC-/V				

all values in mm



Pinout and Dimensions

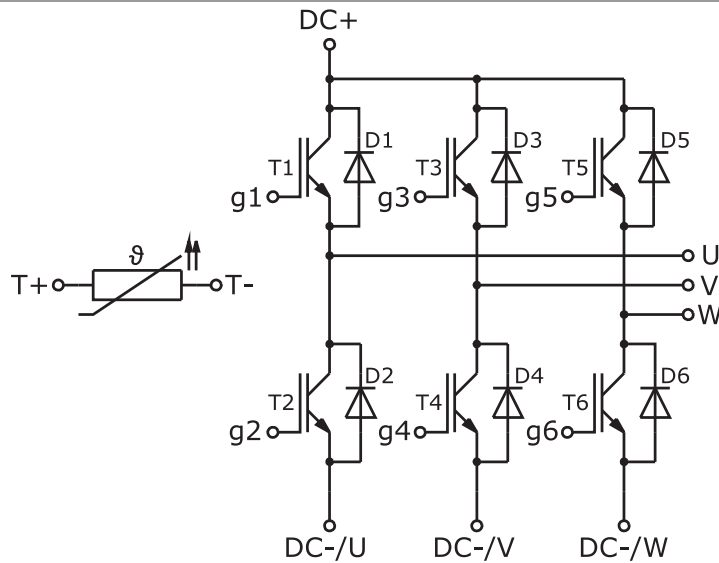

Pinout

This is an electrostatic discharge sensitive device (ESDS) due to international standard IEC 61340.

***IMPORTANT INFORMATION AND WARNINGS**

The specifications of SEMIKRON products may not be considered as guarantee or assurance of product characteristics ("Beschaffenheitsgarantie"). The specifications of SEMIKRON products describe only the usual characteristics of products to be expected in typical applications, which may still vary depending on the specific application. Therefore, products must be tested for the respective application in advance. Application adjustments may be necessary. The user of SEMIKRON products is responsible for the safety of their applications embedding SEMIKRON products and must take adequate safety measures to prevent the applications from causing a physical injury, fire or other problem if any of SEMIKRON products become faulty. The user is responsible to make sure that the application design is compliant with all applicable laws, regulations, norms and standards. Except as otherwise explicitly approved by SEMIKRON in a written document signed by authorized representatives of SEMIKRON, SEMIKRON products may not be used in any applications where a failure of the product or any consequences of the use thereof can reasonably be expected to result in personal injury. No representation or warranty is given and no liability is assumed with respect to the accuracy, completeness and/or use of any information herein, including without limitation, warranties of non-infringement of intellectual property rights of any third party. SEMIKRON does not assume any liability arising out of the applications or use of any product; neither does it convey any license under its patent rights, copyrights, trade secrets or other intellectual property rights, nor the rights of others. SEMIKRON makes no representation or warranty of non-infringement or alleged non-infringement of intellectual property rights of any third party which may arise from applications. Due to technical requirements our products may contain dangerous substances. For information on the types in question please contact the nearest SEMIKRON sales office. This document supersedes and replaces all information previously supplied and may be superseded by updates. SEMIKRON reserves the right to make changes.